

# **BM450, BM451, BM454, BM455, BM484, BM485**

Microwave Oven

# Table of contents

## INFORMATION FOR USE

1	Safety .....	2
2	Preventing material damage .....	5
3	Environmental protection and saving energy .....	6
4	Familiarising yourself with your appliance .....	7
5	Accessories .....	9
6	Before using for the first time .....	10
7	Basic operation .....	10
8	Microwave .....	11
9	Oven .....	11
10	Grill .....	12
11	MicroCombi .....	13
12	Sequential operation .....	13
13	Automatic programmes .....	14
14	Individual recipes .....	17
15	Timer functions .....	18
16	Childproof lock .....	19
17	Basic settings .....	19
18	Cleaning aid .....	21
19	Cleaning and servicing .....	21
20	Troubleshooting .....	24
21	Disposal .....	25
22	Customer Service .....	26
23	How it works .....	26
24	INSTALLATION INSTRUCTIONS .....	37
24.1	Safe installation .....	37

## 1 Safety

Observe the following safety instructions.

### 1.1 General information

- Read this instruction manual carefully.
- Keep the instruction manual and the product information safe for future reference or for the next owner.
- Do not connect the appliance if it has been damaged in transit.

### 1.2 Intended use

Only a licensed professional may connect appliances without plugs. Damage caused by incorrect connection is not covered under the warranty.

The appliance can only be used safely if it is correctly installed according to the safety instructions. The installer is responsible for ensuring that the appliance works perfectly at its installation location.

Only use this appliance:

- To prepare meals and drinks.
- For household use and similar applications, such as: In kitchens for employees in shops, offices and other commercial sectors; in agriculture; by customers in hotels and other residential facilities; in bed and breakfasts.
- up to an altitude of max. 4000 m above sea level.

This appliance complies with the standards EN 55011 and CISPR 11. It is a group 2, class B product. Group 2 means that microwaves are produced for the purpose of heating food. Class B means that the appliance is suitable for private households.

### 1.3 Restriction on user group

This appliance may be used by children aged 8 or over and by people who have reduced physical, sensory or mental abilities or inadequate experience and/or knowledge, provided that they are supervised or have been instructed on how to use the appliance safely and have understood the resulting dangers.

Do not let children play with the appliance.

Children must not perform cleaning or user maintenance unless they are at least 15 years old and are being supervised.

Keep children under the age of 8 years away from the appliance and power cable.

### 1.4 Safe use

Always place accessories in the cooking compartment the right way round.

→ "Accessories", Page 9

#### **WARNING – Risk of fire!**

Combustible objects that are left in the cooking compartment may catch fire.

- ▶ Never store combustible objects in the cooking compartment.

- ▶ If smoke is emitted, the appliance must be switched off or the plug must be pulled out and the door must be held closed in order to stifle any flames.

Loose food remnants, fat and meat juices may catch fire.

- ▶ Before using the appliance, remove the worst of the food residues and remnants from the cooking compartment, heating elements and accessories.

Opening the appliance door creates a draught. Greaseproof paper may come into contact with the heating element and catch fire.

- ▶ Never place greaseproof paper loosely over accessories when preheating the appliance and while cooking.
- ▶ Always cut greaseproof paper to size and use a plate or baking tin to hold it down.

### **⚠ WARNING – Risk of burns!**

The appliance and its parts that can be touched become hot during use.

- ▶ Caution should be exercised here in order to avoid touching heating elements.
- ▶ Young children under 8 years of age must be kept away from the appliance.

Accessories and cookware get very hot.

- ▶ Always use oven gloves to remove accessories or cookware from the cooking compartment.

When the cooking compartment is hot, any alcoholic vapours inside may catch fire. The appliance door may spring open. Hot steam and jets of flame may escape.

- ▶ Only use small quantities of drinks with a high alcohol content in food.
- ▶ Do not heat spirits ( $\geq 15\%$  vol.) when undiluted (e.g. for marinating or pouring over food).
- ▶ Open the appliance door carefully.

### **⚠ WARNING – Risk of scalding!**

The accessible parts of the appliance become hot during operation.

- ▶ Never touch these hot parts.
- ▶ Keep children at a safe distance.

Hot steam may escape when you open the appliance door. Steam may not be visible, depending on the temperature.

- ▶ Open the appliance door carefully.

- ▶ Keep children at a safe distance.

If there is water in the cooking compartment when it is hot, this may create hot steam.

- ▶ Never pour water into the cooking compartment when the cooking compartment is hot.

### **⚠ WARNING – Risk of injury!**

Scratched glass in the appliance door may develop into a crack.

- ▶ Do not use any harsh or abrasive cleaners or sharp metal scrapers to clean the glass on the appliance door, as they may scratch the surface.

The hinges on the appliance door move when the door is opened and closed, which could trap your fingers.

- ▶ Keep your hands away from the hinges.

### **⚠ WARNING – Risk of electric shock!**

Incorrect repairs are dangerous.

- ▶ Repairs to the appliance should only be carried out by trained specialist staff.
- ▶ Only use genuine spare parts when repairing the appliance.
- ▶ If the power cord of this appliance is damaged, it must be replaced by the manufacturer, the manufacturer's Customer Service or a similarly qualified person in order to prevent any risk.

If the insulation of the power cord is damaged, this is dangerous.

- ▶ Never let the power cord come into contact with hot appliance parts or heat sources.
- ▶ Never let the power cord come into contact with sharp points or edges.
- ▶ Never kink, crush or modify the power cord.

An ingress of moisture can cause an electric shock.

- ▶ Do not use steam- or high-pressure cleaners to clean the appliance.

If the appliance or the power cord is damaged, this is dangerous.

- ▶ Never operate a damaged appliance.
- ▶ Never operate an appliance with a cracked or fractured surface.
- ▶ If the appliance or the power cable is damaged, immediately switch off the fuse in the fuse box.
- ▶ Call customer services. → Page 26

**⚠ WARNING – Risk of suffocation!**

Children may put packaging material over their heads or wrap themselves up in it and suffocate.

- ▶ Keep packaging material away from children.
- ▶ Do not let children play with packaging material.

Children may breathe in or swallow small parts, causing them to suffocate.

- ▶ Keep small parts away from children.
- ▶ Do not let children play with small parts.

### 1.5 Microwave

CAREFULLY READ THE IMPORTANT SAFETY INSTRUCTIONS AND KEEP THEM SAFE FOR FUTURE USE

**⚠ WARNING – Risk of fire!**

Using the appliance for anything other than its intended purpose is dangerous and may cause damage. For example, heated slippers and pillows filled with grain or cereal may catch fire, even several hours later.

- ▶ Never dry food or clothing with the appliance.
- ▶ Never heat up slippers, pillows filled with grain or cereal, sponges, damp cleaning cloths or similar with the appliance.
- ▶ The appliance must only be used to prepare food and drink.

Food and its packaging and containers may catch fire.

- ▶ Never heat food in heat-retaining packaging.
- ▶ Do not leave food unattended while it is heating in containers made of plastic, paper or other combustible materials.
- ▶ Never set the microwave power too high or the cooking time too long. Follow the instructions provided in this user manual.
- ▶ Never use the microwave to dry food.
- ▶ Never defrost or heat food with a low water content, such as bread, at too high a microwave power or for too long.

Cooking oil may catch fire.

- ▶ Never use the microwave to heat cooking oil on its own.

**⚠ WARNING – Risk of explosion!**

Liquids and other food may easily explode when in containers that have been tightly sealed.

- ▶ Never heat liquids or other food in containers that have been tightly sealed.

**⚠ WARNING – Risk of burns!**

Foods with peel or skin may burst or explode during heating, or even afterwards.

- ▶ Never cook eggs in their shell or heat hard-boiled eggs in their shell.
- ▶ Never cook shellfish or crustaceans.
- ▶ Always prick the yolk of eggs before microwaving.
- ▶ The skin of foods that have a peel or skin, such as apples, tomatoes, potatoes and sausages, may burst. Before heating, prick the peel or skin.

Heat is not distributed evenly through baby food.

- ▶ Never heat baby food in closed containers.
- ▶ Always remove the lid or teat.
- ▶ Stir or shake well after heating.
- ▶ Check the temperature before giving the food or drink to a child.

Heated food gives off heat. The cookware may become hot.

- ▶ Always use oven gloves to remove cookware or accessories from the cooking compartment.

Airtight packaging may burst when food is heated.

- ▶ Always follow the instructions on the packaging.
- ▶ Always use oven gloves to remove the dishes from the cooking compartment.

The accessible parts of the appliance become hot during operation.

- ▶ Never touch these hot parts.
- ▶ Keep children at a safe distance.

Using the appliance for anything other than its intended purpose is dangerous. This is because, for instance, overheated slippers, pillows filled with grain or cereal, sponges and damp cleaning cloths, etc., may cause burns to the skin.

- ▶ Never dry food or clothing with the appliance.
- ▶ Never heat up slippers, pillows filled with grain or cereal, sponges, damp cleaning cloths or similar with the appliance.
- ▶ The appliance must only be used to prepare food and drink.

**⚠ WARNING – Risk of scalding!**

There is a possibility of delayed boiling when a liquid is heated. This means that the liquid reaches the boiling temperature without the usual steam bubbles rising to the surface. Exercise caution even when only gently shaking the container. The hot liquid may suddenly boil over and splatter.

- ▶ Always place a spoon in the container when heating liquids. This prevents delayed boiling.

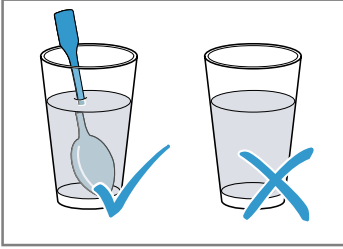
**⚠ WARNING – Risk of injury!**

Unsuitable cookware may crack. Porcelain or ceramic cookware can have small perforations in the handles and lid. These perforations conceal a cavity below. If moisture penetrates this cavity, it could cause the cookware to crack.

- ▶ Only use microwave-safe cookware. Cookware and containers made from metal or cookware with metal edging may lead to sparks being formed during simple microwave operation. The appliance is damaged.

- ▶ Never use metal containers during microwave-only operation.
- ▶ Only use microwave-safe cookware or use the microwave in combination with a type of heating.

**⚠ WARNING – Risk of electric shock!**

The appliance uses a high voltage.

- ▶ Never remove the casing.

**⚠ WARNING – Risk of serious harm to health!**

Inadequate cleaning may destroy the surface of the appliance, reduce its service life, and lead to dangerous situations, such as escaping microwave energy.

- ▶ Clean the appliance on a regular basis, and remove any food residue immediately.
- ▶ Always keep the cooking compartment, door seal, door and door stop clean.  
→ "Cleaning and servicing", Page 21

Never operate the appliance if the cooking compartment door or the door seal is damaged. Microwave energy may escape.

- ▶ Never use the appliance if the cooking compartment door, the door seal or the plastic door frame is damaged.
- ▶ Any repair work must only be carried out by customer service.

Microwave energy will escape from appliances that do not have any casing.

- ▶ Never remove the casing.
- ▶ Contact our after-sales service if maintenance or repair work is needed.

## 2 Preventing material damage

### 2.1 General

**ATTENTION!**

Alcoholic vapours may catch fire in the hot cooking compartment and cause permanent damage to the appliance. The appliance door may spring open due to an explosion and it may fall off. The door panels may shatter and fragment. Due to the resulting negative pressure, the cooking compartment may become considerably deformed inwards.

- ▶ Do not heat spirits ( $\geq 15\%$  vol.) when undiluted (e.g. for marinating or pouring over food).

When the cooking compartment is hot, any water inside it will create steam. The change in temperature may cause damage.

- ▶ Never pour water into the cooking compartment when it is still hot.

The prolonged presence of moisture in the cooking compartment leads to corrosion.

- ▶ Always wipe away the condensation after cooking. Always allow the cooking compartment to cool down with the door closed after cooking at high temperatures.
- ▶ Do not keep moist food in the cooking compartment for a long time with the door closed.
- ▶ Do not store food in the cooking compartment.
- ▶ Take care not to trap anything in the appliance door.

If the seal is very dirty, the appliance door will no longer close properly during operation. This may damage the front of adjacent kitchen units.

- ▶ Keep the seal clean at all times.
- ▶ Never operate the appliance if the seal is damaged or missing.

Sitting or placing objects on the appliance door may damage it.

- ▶ Do not place, hang or support objects on the appliance door.

## 2.2 Microwave

Follow these instructions when using the microwave.

### ATTENTION!

Metal touching the wall of the cooking compartment will cause sparks, which may damage the appliance or the inner door pane.

- ▶ Metal (e.g. a spoon in a glass) must be kept at least 2 cm from the cooking compartment walls and the inside of the door.

Placing aluminium containers in the appliance may cause sparks, which will damage the appliance.

- ▶ Do not use aluminium containers in the appliance.

Operating the appliance without food in the cooking compartment may lead to overloading.

- ▶ Do not switch on the microwave unless there is food inside. The only exception to this rule is when performing a short cookware test.

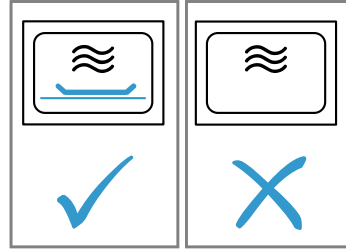

If you prepare several bags of microwave popcorn in immediate succession at a microwave power level that is too high, the cooking compartment may be damaged.

- ▶ Leave the appliance to cool down for several minutes between each use.
- ▶ Never set a microwave power level that is too high.
- ▶ Use a maximum microwave output of 600 watts.
- ▶ Always place the popcorn bag on a glass plate.

Using unsuitable cookware may result in damage.

- ▶ When using the grill, the microwave combi mode or the hot air, only use tableware that can withstand the high temperatures.

---

## 3 Environmental protection and saving energy

### 3.1 Disposing of packaging

The packaging materials are environmentally compatible and can be recycled.

- ▶ Sort the individual components by type and dispose of them separately.

### 3.2 Saving energy

If you follow these instructions, your appliance will use less power.

Only preheat the appliance if the recipe or the recommended settings tell you to do so.

- Not preheating the appliance can reduce the energy used.

Use dark-coloured, black-coated or enamelled baking tins.

- These types of baking tin absorb the heat particularly well.

When cooking multiple dishes, do so in succession or in parallel.

- The cooking compartment is heated after cooking the first dish. This reduces the cooking time for the following dishes.

If the cooking time is relatively long, you can switch the appliance off 10 minutes before the cooking time ends.

- There will be enough residual heat to finish cooking the dish.

Hide the clock in standby mode.

- The appliance saves energy in standby mode.

Open the appliance door as little as possible during operation.

- This will maintain the temperature in the cooking compartment and eliminate the need for the appliance to reheat.

#### Note:

The appliance requires:

- A maximum of 1 W in standby mode with the display switched on
- A maximum of 0.5 W in standby mode with the display switched off

## 4 Familiarising yourself with your appliance

### 4.1 Control panel

You can use the control panel to configure all functions of your appliance and to obtain information about the operating status.

**Note:** On certain models, specific details such as colour and shape may differ from those pictured.

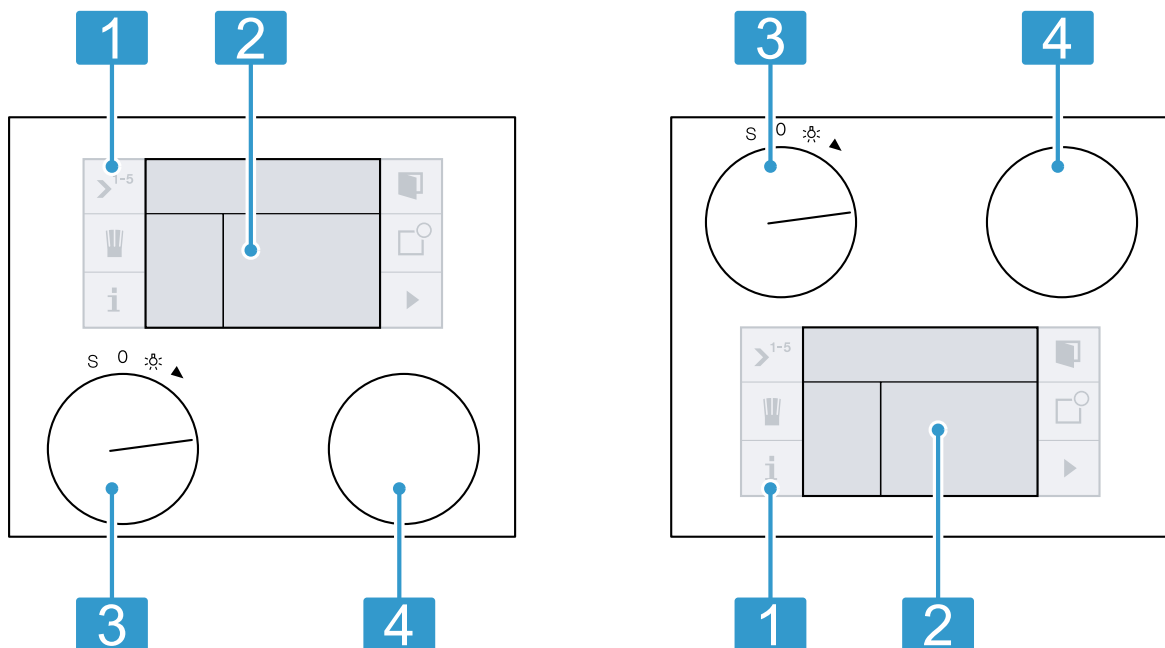

<b>1</b>	Touch fields	You can use the touch fields to set various functions directly.
<b>2</b>	Display	The display shows the current setting values and selection options.
<b>3</b>	Function selector	Use the function selector to set the microwave output setting, type of heating and other functions.
<b>4</b>	Rotary selector	Use the rotary selector to change the settings in the different operating modes.

#### Positions of the function selector

















Use the function selector to select the functions or types of heating.

Position	Function
0	Zero setting
☀	Light
2	1000 W microwave
3	600 W microwave
4	360 W microwave
5	180 W microwave
6	90 W microwave
7	☼ Hot air
8	☼ Full surface grill + hot air
9	☼ Full surface grill + air recirculation
10	☼ Grill
S	Basic settings





#### Symbols

Use the symbols to start or stop functions, or to navigate in the menu.







Symbol	Function
▶	Start
■	Stop
	Pause or end
X	Cancel
C	Delete
✓	Confirm or save settings
>	Selection arrow
🔊	Open the appliance door
i	Call up additional information

Symbol	Function
	Calling up additional tips
	Calling up the automatic programmes Calling up individual recipes
	Saving
	Edit settings
	Childproof lock
	Call up the timer menu
	Call up the long-term timer
	Sequential operation
	Record menu
	Enter a name
	Delete letters
	Microwave, letting the dish rest
	Demo mode
	Heating with status display
	Rapid heating with status display
	Short-term timer
	Stopwatch

#### Automatic programs

	Weight
	Cooking result
	Defrosting
	Cooking and combi cooking

#### Combination mode

	Calling up the oven
	Removing the oven
	Adding the oven
	Calling up the microwave
	Removing the microwave
	Adding the microwave

#### Colours and display

The different colours guide the user in the relevant setting situations.

#### Colours

Orange	<ul style="list-style-type: none"> <li>■ Initial settings</li> <li>■ Main functions</li> </ul>
Blue	Basic settings
White	Adjustable values

#### Display

The symbols, values and displays change, depending on the situation.

Zoom	Values and symbols that have just been selected are displayed in a larger font.
Reduced display	After a short time, the information shown on the display is reduced and only the most important information remains. You can change this preset function in the basic settings. → Page 19

#### 4.2 Automatic door opening

If you press , the appliance door springs open. Use the recessed grip on the side of the appliance to open the appliance door fully.

**Note:** If the childproof lock is activated or in the event of a power cut, the automatic door opening function does not work. Use the recessed grip on the side of the appliance to open the appliance door manually.

#### 4.3 Additional Information

Press **i** to call up additional information.

Before starting, you receive information, e.g. about the type of heating. You can therefore check whether the current setting is suitable for the dish.

During operation, you receive information, e.g. about the time that has elapsed and the time remaining.

**Note:** During continuous operation after heating up, slight temperature fluctuations are normal.

#### 4.4 Cooking compartment

The functions in the cooking compartment make your appliance easier to use.

##### Interior lighting

When you open the appliance door, the lighting in the cooking compartment switches on. If the appliance door remains open, the light switches off again after a short time.

When the operation starts, the interior lighting switches on.

##### Cooling fan

The cooling fan switches on and off as required. The hot air escapes through the ventilation slots above the appliance door.

##### ATTENTION!

Covering the ventilation slots will cause the appliance to overheat.

- ▶ Do not cover the ventilation slots.

To cool the cooking compartment more quickly after operation, the cooling fan continues to run for a certain period afterwards. If the appliance is running in microwave operation, the appliance remains cool, but the cooling fan still switches on. The cooling fan may continue to run even when microwave operation has ended.



## Condensation

Condensation can occur in the cooking compartment and on the appliance door when cooking. Condensation is normal and does not adversely affect appliance operation. Wipe away the condensation after cooking.

## Shelf positions

The cooking compartment has 4 shelf positions. The shelf positions are numbered from bottom to top. Insert the accessory into the guide and slide it in fully. The cooking compartment floor at position 0 is particularly suitable for microwave operation. The microwave output is best on the cooking compartment floor. Only use microwave-safe cookware.

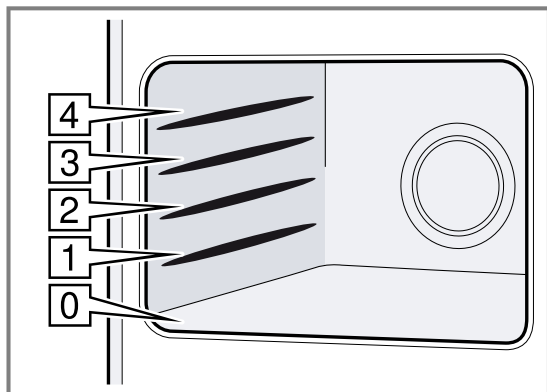

## 4.5 Standby

The appliance switches to standby mode if you have not set any function or activated the childproof lock. In standby mode, the brightness of the control panel is reduced.

Different things can be displayed in standby mode. The GAGGENAU logo and the time are preset.

The brightness of the display depends on the vertical viewing angle. You can change the display and the brightness at any time in the basic settings.

→ "Basic settings", Page 19

## 4.6 Safety shut-off

For your safety, your appliance has a safety shut-off function. If you do not operate your appliance for 12 hours, your appliance switches every kind of heating off and the display shows a message.

This excludes programming using a long-term timer. If you turn the function selector to 0, you are now able to start the appliance again as usual.

# 5 Accessories

Use original accessories. These have been made especially for your appliance.

The accessories supplied may differ depending on the appliance model.

## Accessories

Wire rack



## Use

- Cookware
- Cake tins
- Grilled items
- Frozen meals

**Tip:** You can pull the wire rack  $\frac{2}{3}$  of the way out without it tipping. You can therefore remove meals more easily.

Glass tray

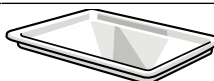

- Large roasts
  - Moist cake
  - Bakes
  - Gratins
  - Splash guard when grilling directly on the wire rack
- When grilling, slide the glass tray in at level 1

**Tip:** You can use the glass tray as a setdown area during microwave operation.

Rod



- Heating liquids in narrow containers
- Preventing delayed boiling
- When heating liquids, always place the rod or a spoon into the container

---

## 6 Before using for the first time

Configure the settings for initial start-up. Clean the appliance and accessories.

### 6.1 Initial start-up

When the appliance is connected to the power supply for the first time or following a lengthy power cut, the settings for the initial start-up of your appliance appear.

**Note:** You can change → *Page 19* these settings at any time in the basic settings.

#### Setting the language

The display shows the preset language.

1. Use the rotary selector to set the required display language.
2. Press ✓ to confirm.

**Note:** When you change the language, the system re-starts. This process takes a few seconds.

#### Setting the time format

The display shows the two possible formats 24h and AM/PM. The 24h time format is preselected.

1. Use the rotary selector to set the required time format.
2. Press ✓ to confirm.

#### Setting the time

The display shows the time.

1. Use the rotary selector to set the required time.
2. Press ✓ to confirm.

#### Setting the date format

The display shows the 3 possible date formats D.M.Y, D/M/Y and M/D/Y. The date format D.M.Y. is preselected.

1. Use the rotary selector to set the required date format.
2. Press ✓ to confirm.

#### Setting the date

The display shows the preset date. The day setting is active.

1. Use the rotary selector to set the required day.
2. Use > to switch to the month setting

3. Use the rotary selector to set the month.
4. Use > to switch to the year setting
5. Use the rotary selector to set the year.
6. Press ✓ to confirm.

#### Setting the temperature format

The display shows the two possible units °C and °F. The unit °C is preselected.

1. Use the rotary selector to set the required unit.
2. Press ✓ to confirm.

#### Ending the initial start-up

The display shows "Initial set-up complete".

- ▶ Press ✓ to confirm.
- ✓ The appliance enters standby mode and the standby screen appears. The appliance is ready to use.

### 6.2 Cleaning the appliance before using it for the first time

Clean the cooking compartment and accessories before using the appliance to prepare food for the first time.

1. Ensure that there is no leftover packaging, accessories or other objects in the cooking compartment.
2. Clean the smooth surfaces in the cooking compartment with a soft, damp cloth.
3. Close the appliance door.
4. Ventilate the room while the appliance is heating.
5. Heat up the appliance for one hour at 200 °C using Grill and Hot air modes .  
→ "Setting the type of heating and the temperature", *Page 12*
6. Allow the appliance to cool down.
7. Once the cooking compartment has cooled down, clean the smooth surfaces with soapy water and a dish cloth.

### 6.3 Cleaning the accessories

- ▶ Clean the accessory thoroughly with soapy water and a soft dish cloth.

---

## 7 Basic operation

### 7.1 Activating the appliance

1. To exit standby mode, open or close the door, turn the function selector or touch a control panel.
2. Set the required function.

#### Notes

- When "Standby screen" = "Off" is selected in the basic settings, turn the function selector to exit standby mode.
- If you do not make any settings for an extended period after activation, the standby display is shown.
- When the door is open, the interior lighting switches off after a short time.

### 7.2 Interrupting the operation

1. To interrupt the operation, press II.
2. Press ▶ to resume operation.

### 7.3 Cancelling the operation

- ▶ To stop the operation and delete the settings, turn the function selector to 0.

**Note:** The fan can also continue to run when the door is open. This is normal.

## 8 Microwave

You can use the microwave to cook, heat up, bake or defrost food very quickly. The microwave can be used on its own or in combination with a type of heating.

### 8.1 Microwave-safe cookware and accessories

To heat food evenly and avoid damaging your appliance, it is important to use the right cookware and accessories.

**Note:** Read the manufacturer's instructions before using any cookware in the microwave. If in doubt, carry out a cookware test.

#### Microwave-safe

Cookware and accessories	Reason
Cookware made from heat-resistant, microwave-safe material: <ul style="list-style-type: none"> <li>■ Glass</li> <li>■ Glass ceramic</li> <li>■ Porcelain</li> <li>■ Temperature-resistant plastic</li> <li>■ Fully glazed ceramic without cracks</li> </ul>	These materials allow microwaves to pass through. Microwaves do not damage heat-resistant cookware.
Metal cutlery	<b>Note:</b> You can use metal cutlery, e.g. place a spoon in a glass, to prevent delayed boiling.

#### ATTENTION!

Metal touching the wall of the cooking compartment will cause sparks, which may damage the appliance or the inner door pane.

- ▶ Metal (e.g. a spoon in a glass) must be kept at least 2 cm from the cooking compartment walls and the inside of the door.

#### Not microwave-safe

Cookware and accessories	Reason
Metal cookware	Metal does not allow microwaves to pass through. The food hardly heats up.
Cookware with gold or silver decoration	Microwaves can damage gold and silver decoration. <b>Tip:</b> You can only use this kind of cookware if the manufacturer guarantees that it is microwave-safe.

### 8.2 Microwave power settings

This is where you can find an overview of the different microwave output settings and when to use them.

Microwave output in watts	Use
90	Defrost delicate foods.
180	Defrost food and continue cooking.
360	Cook meat and fish or heat delicate foods.
600	Heat and cook food.
1000	Heat liquids.

#### Notes

- You can set the microwave output settings for a specific duration:
  - 1000 W for 30 minutes
  - 90 W, 180 W, 360 W and 600 W for 90 minutes
- The maximum setting is for heating liquids. To protect the appliance, it reduces the maximum microwave output setting after some time. Full power is made available again after a cooling period.

### 8.3 Setting the microwave

1. Use the function selector to set the required microwave output setting.
2. Use the rotary selector to set the cooking time.
3. Press ► to start.
  - ✓ The appliance starts. You can see the cooking time counting down.
  - ✓ A signal tone sounds once the time has elapsed. If you press ✓, open the appliance door or set the function selector to 0, you can end the signal early. The operation has finished.

**Note:** If you open the appliance door during cooking, the microwave operation stops. To continue the operation, close the appliance door and press ►.

#### Tips





- You can change the duration at any time using the rotary selector.
- You can change the output at any time using the function selector. To start, press ►.
- You can call up the elapsed cooking time by pressing **i**. If you press ✓, you return to the standard display.

## 9 Oven





Your appliance has an oven mode.

## 9.1 Oven levels

In oven mode, you can set different types of heating.

Symbol	Type of heating	Temperature in °C	Use
	Hot air	40	<ul style="list-style-type: none"> <li>■ Leave the yeast dough to prove.</li> <li>■ Defrost cream cakes.</li> </ul>
	Hot air	100-250	Bake cakes, small baked goods, and pizza on the glass tray.
	Grill + Hot air	100-250	Roast pieces of meat.
	Grill + Air recirculation	100-250	<ul style="list-style-type: none"> <li>■ Bakes</li> <li>■ Gratinated poultry</li> <li>■ Whole poultry</li> </ul>

## 9.2 Setting the type of heating and the temperature

1. Use the function selector to set the required type of heating, e.g. Hot air.
  - ✓ The display shows  and the default temperature 180 °C.
2. Use the rotary selector to set the temperature.
3. If required, set the cooking time and move the cooking time end to a later time:
  - Press **><sup>1-5</sup>** to call up the sequential operation.
  - Use **>** to select and set the "Cooking time"  function.
  - Use **>** to select and set the "Cooking time end"  function.
4. Press **▶** to start.
  - ✓ From a temperature of 100 °C, the display shows the heating symbol .
  - ✓ The bar shows the current heat-up status. Once the set temperature has been reached, a signal tone sounds and  goes out.

**Note:** You can activate or deactivate a heat-up signal in the basic settings. The signal tone sounds when the required temperature is reached.

### Tips

- You can change the temperature at any time using the rotary selector.
- You can change the type of heating at any time using the function selector. To start, press **▶**.

### Interrupting the operation

1. To interrupt the operation, press **||**.
2. Press **▶** to resume operation.

### Cancelling the operation

- ▶ To stop the operation and delete the settings, turn the function selector to **0**.

**Note:** The fan can also continue to run when the door is open. This is normal.

### Displaying the current temperature

1. To display the interior temperature, press **i**.
  - ✓ The display shows temperatures of 100 °C and above for a few seconds.
2. To return to the standard display, press **✓**.

**Note:** During continuous operation after heating up, slight deviations in temperature are normal, depending on the heating function.

## 9.3 Rapid heating

With the "Rapid heating" function, your appliance reaches the required temperature particularly quickly. Place your food in the cooking compartment only once the "Rapid heating" has ended. This achieves an even cooking result.

You must activate → Page 19 the "Rapid heating" in the basic settings.

When the "Rapid heating" is activated, the display shows .

# 10 Grill

You can brown or gratinate your food using the grill. You can use the grill on its own or in combination with the microwave.

## 10.1 Grill settings



Your appliance has multiple grill settings.

Grill setting	Use
1 (low)	<ul style="list-style-type: none"> <li>■ Soufflés</li> <li>■ Deep-dish bakes</li> </ul>

Grill setting	Use
2 (medium)	<ul style="list-style-type: none"> <li>■ Shallow bakes</li> <li>■ Fish</li> </ul>
3 (high)	<ul style="list-style-type: none"> <li>■ Steaks</li> <li>■ Sausages</li> <li>■ Toast</li> </ul>

## 10.2 Setting Grill mode

1. Use the function selector to set the full surface grill.
  - ✓ The display shows  and grill setting 3.
2. Use the rotary selector to set the grill setting.
3. If required, set the cooking time and move the cooking time end to a later time:
  - Press **><sup>1-5</sup>** to call up the sequential operation.

- Use > to select and set the "Cooking time"  function.
  - Use > to select and set the "Cooking time end"  function.
4. Press ▶ to start.

### Tips

- You can use the rotary selector to change the grill setting at any time.
- You can use the function selector to change the operation mode at any time. To start, press ▶.

## 11 MicroCombi



To reduce the cooking time and brown your meals, you can use the oven type of heating or grill in combination with the microwave.

### Notes

- You can switch on all microwave output settings except for 1000 W.
- You can also combine the MicroCombi with the sequential operation for the microwave.

### 11.1 Setting MicroCombi

**Note:** You can start combined operation with an oven type of heating or microwave output setting.

1. Use the function selector to set the required oven type of heating or microwave output setting.
2. Use the rotary selector to set the oven temperature or grill setting.
  - ✓ Depending on the operating mode selected, the  symbol for microwave or the  symbol for oven appears in the right-hand control panel. This enables you to add the relevant other operating mode.
3. Use  to add a microwave output setting.
4. Use the function selector to set the required microwave output setting.
5. Use the rotary selector to set the cooking time.
6. Press ▶ to start.
  - ✓ The appliance starts. You can see the cooking time counting down.
  - ✓ A signal tone sounds once the time has elapsed. If you press ✓, open the appliance door or set the function selector to 0, you can end the signal early. The operation has finished.

### Interrupting the operation

1. To interrupt the operation, press **||**.
2. Press ▶ to resume operation.



### Cancelling the operation

- ▶ To stop the operation and delete the settings, turn the function selector to 0.





**Note:** The fan can also continue to run when the door is open. This is normal.

### Changing settings

You can change the oven type of heating, the cooking compartment temperature, the grill setting or the microwave output setting and the duration.

1. To change the settings during the operation and stop the operation, press **||**.
2. Choose the operating mode using  or .
3. Use the function selector to change the oven type of heating or microwave output setting.
4. Use the rotary selector to change the interior temperature, the grill setting or the duration of the microwave output setting.
5. Press ▶ to start.

### Deleting settings

1. To delete the settings during the operation and stop the operation, press **||**.
2. Choose the operating mode using  or .
3. Use  or  to delete the type of heating.
4. Press ▶ to start.

### Interrupting the operation

1. To interrupt the operation, press **||**.
2. Press ▶ to resume operation.

### Cancelling the operation

- ▶ To stop the operation and delete the settings, turn the function selector to 0.

**Note:** The fan can also continue to run when the door is open. This is normal.

## 12 Sequential operation

With a sequential operation, you can set up to 5 different types of heating and cooking times that are set one after another.

### 12.1 Setting a sequential operation

1. Use the function selector to set the required microwave output setting or oven type of heating.
2. Press ><sup>1-5</sup>.
  - ✓ The sequential operation menu is displayed.
3. Use the rotary selector to set the cooking time, temperature or grill setting.
4. Use > to select the second phase.
5. **Note:** You can set a compensation time between 2 microwave output settings so that the temperature can be evenly distributed in the food. To set the compensation time, press 0<sub>w</sub> and use the rotary selector to set a duration.
  - Use the function selector to set the required microwave output setting or oven type of heating.
6. Use the rotary selector to set the cooking time, temperature or grill setting.
7. Use > to select the third phase.
8. Use the function selector to set the required microwave output setting or oven type of heating.
9. Use the rotary selector to set the cooking time, temperature or grill setting.

10. Use > to select "Cooking time" ⌚.
11. Use the rotary selector to set the required cooking time.
12. Press ✓ to confirm.
  - ✓ The main menu for the sequential operation is displayed. The settings for the phases are shown on the display bar.
13. Press ▶ to start.
  - ✓ The appliance starts. You can see the cooking time counting down.
  - ✓ Once the cooking time has elapsed, the appliance switches off. A signal tone sounds. If you press ✓, open the appliance door or set the function selector to 0, you can end the signal early. The operation has finished.

#### Notes

- You can add the combined operation to the sequential operation.
- You can only select the 1000 W microwave output setting once.
- You cannot combine the oven types of heating with the 1000 W microwave output setting.
- The order of each setting is entirely up to you. You can start the duration, microwave output setting or oven type of heating.
- If you open the appliance door during cooking, the fan may continue to run.

#### Changing sequential operation

1. Press II.
  - ✓ The operation stops.
2. Use the rotary selector to set the cooking time, temperature or grill setting.
3. Press ><sup>1-5</sup> and change the settings.
4. Use ✓ to exit the menu.
5. Press ▶ to start.

#### Deleting settings

- ▶ Press X.

#### Interrupting the operation

1. To interrupt the operation, press II.
2. Press ▶ to resume operation.

#### Cancelling the operation

- ▶ To stop the operation and delete the settings, turn the function selector to 0.

**Note:** The fan can also continue to run when the door is open. This is normal.

## 12.2 Cooking time end

In oven mode, you can delay the cooking time end to a later time. This function is not available in combination with the microwave.

Enter the cooking time and delay the cooking time end until 15:30, for example. The electronics system calculates the start time. The appliance starts automatically at 14:50 and switches off at 15:30, for example. Do not leave food which spoils easily in the oven for too long.

#### Delaying the cooking time end

**Requirement:** The type of heating, temperature and cooking time are set.

1. Use > to select "Cooking time end" ⌚.
2. Use the rotary selector to set the required cooking time end.
3. Press ✓ to confirm.
  - ✓ The display shows a notification that a cooking time end has been set.
4. Press ✓ to confirm.
5. Press ▶ to start.
  - ✓ The appliance switches to standby. The display shows the operating mode, the temperature, the cooking time and the remaining time until the start.
  - ✓ The appliance starts at the calculated time and automatically switches off once the cooking time has elapsed.
  - ✓ Once the cooking time has elapsed, the appliance switches off. A signal tone sounds. If you press ✓, open the appliance door or set the function selector to 0, you can end the signal early. The operation has finished.

#### Changing the cooking time

1. Press II.
2. Use > to select "Cooking time" ⌚.
3. Use the rotary selector to set the required cooking time.
4. Press ✓ to confirm.
5. Press ▶ to start.

#### Changing the cooking time end

1. Press II.
2. Use > to select "Cooking time end" ⌚.
3. Use the rotary selector to set the required cooking time end.
4. Press ✓ to confirm.
5. Press ▶ to start.

#### Deleting settings

- ▶ Press X.

#### Cancelling the entire procedure

- ▶ Turn the function selector to 0.

---

## 13 Automatic programmes

The automatic programs help you prepare different dishes and automatically select the optimal settings.

### 13.1 Information on Automatic programmes

Follow these tips to achieve optimal cooking results:

- Only use food that is in perfect condition.

- Take the food out of its packaging and weigh it. If you cannot set the exact weight on the appliance, round the weight up or down.
- Only use microwave-safe, heat-resistant cookware, e.g. made of glass or ceramic.
- Place the food in the cold cooking compartment.

- It is not possible to set weights outside the weight range.
- With many dishes, a signal tone sounds after a certain time. Turn or stir the food.

### Defrosting

- Freeze and store food flat and in portion-sized quantities at -18 °C.
- Place the frozen food on flat cookware, such as a glass or porcelain plate.
- Food may not be completely defrosted by the end of the programme. The food can nonetheless be further processed.
- The defrosted food should be left to stand for an additional 15 to 90 minutes until it reaches an even temperature.
- Liquid is produced when defrosting meat or poultry. When turning, drain off any liquid. Do not reuse the liquid for other purposes or allow it to come into contact with other foods.
- Bread and bread rolls become hard quickly. Defrost only in the required amounts.
- Place frozen bread rolls in the oven. Only pre-baked bread rolls are suitable.
- After turning, remove any minced meat that has already defrosted.
- Whole poultry should be placed in the cookware breast-side down.

### Vegetables

- Fresh vegetables: Cut into pieces of equal size. Add one tablespoon of water per 100 g.
- Frozen vegetables: Only suitable for blanched, not pre-cooked vegetables. It is not suitable for frozen vegetables in cream sauce. Add 1 to 3 tablespoons of water. Do not add any water for spinach or red cabbage.

### Potatoes

- Baked potatoes: Use potatoes of the same thickness. Wash, dry and prick the skin.

### Rice

- Do not use brown rice or boil-in-the-bag rice.
- Add two to two-and-a-half times the amount of water to the rice.

### Fish

- Fresh fish fillet: Add 1 to 3 tablespoons of water or lemon juice.

### Leg of lamb

- First, put the fat side facing down in the cookware. The leg of lamb should cover two thirds of the base of the cookware. Add 50-100 ml of liquid.

### Poultry

- Only use chicken portions at refrigerator temperature.
- Prick the skin here and there with a fork.
- Place the chicken in the dish breast-side down.
- Place chicken portions in the cookware skin-side up.

### Pizza, frozen

- Use pre-baked, frozen pizza with thin crust.

## 13.2 Resting time

Some dishes require a resting time in the cooking compartment after the programme has ended.

Dish	Resting time
Vegetables	Approx. 5 minutes
Potatoes	Approx. 5 minutes First pour off the remaining water.
Rice	Approx. 5-10 minutes
Frying	Approx. 10 minutes

## 13.3 Setting a programme

1. Set the function selector to any operating mode. The function selector must not be moved to  $\text{☼}$  or S S.
  2. Press  $\text{⏏}$  to display the automatic programs.
  3. Press  $\text{✓}$  to confirm.
- ✓ The display shows the first programme.
4. Use the rotary selector to select the desired programme.
  5. Use  $\text{↵}$  to select the  $\text{☼}$  function.
  6. Turn the rotary selector to set the weight.
  7. Press  $\text{✓}$  to confirm.
  8. Press  $\text{▶}$  to start.
- ✓ The appliance starts. You can see the cooking time counting down.
- ✓ A signal tone sounds once the time has elapsed. If you press  $\text{✓}$ , open the appliance door or set the function selector to 0, you can end the signal early. The operation has finished.

### Displaying tips

1. To display tips on the cookware, accessories or the shelf positions, press  $\text{☼}$ .
2. Press  $\text{✓}$  to exit the display.

### Displaying notifications

**i**<sup>®</sup> appears for important information and indicates that an action is required.

1. Press **i** to display notifications for the preparation.
2. Press  $\text{✓}$  to exit the display.

### Notes

- For some dishes, the display provides instructions for turning or stirring during preparation. Follow the information provided.  
If you do not turn or stir the dish, the programme runs as normal until it reaches the end.
- Opening the appliance door pauses the operation. After closing the appliance door, continue the operation by pressing  $\text{▶}$ .

### Interrupting the operation

1. To interrupt the operation, press **||**.
2. Press  $\text{▶}$  to resume operation.

### Cancelling the operation



- ▶ To stop the operation and delete the settings, turn the function selector to 0.



**Note:** The fan can also continue to run when the door is open. This is normal.



### 13.4 Adjusting the programme

If the cooking result does not meet your expectations, you can adjust the programme.

1. Use  to select the individual settings.
2. Use  to select "Cooking result" .
3. Use the rotary selector to set the cooking result.
  - To reduce the cooking result, turn it anticlockwise.
  - To increase the cooking result, turn it clockwise.

4. Press  to confirm.
  - ✓ The display switches to the programme and the cooking time changes.
5. Press  to confirm.
6. Press  to start.
  - ✓ The appliance starts. You can see the cooking time counting down.

**Note:** The change only applies for the current programme flow.

### 13.5 Programme table

You can cook food very easily using the programmes. You select a programme and enter the weight of your food. The programme applies the most suitable settings.

#### Defrosting

Dish	Suitable food	Weight range in kg	Cookware or accessories, shelf height
Loaf of bread <sup>1</sup>	Wheat bread, mixed wheat bread, wholemeal bread	0.20 – 1.50	Shallow cookware without lid Cooking compartment floor
Bread rolls	Wheat rolls, pre-baked	0.05 – 0.60	Wire rack Position 1
Minced meat <sup>1</sup>	Minced beef, lamb, or pork	0.20 – 1.00	Shallow cookware without lid Cooking compartment floor
Whole poultry <sup>1</sup>	Chicken, duck	0.70 – 2.00	Shallow cookware without lid Cooking compartment floor

<sup>1</sup> Observe the signals given when it is time to turn the food.

#### Cooking

Dish	Suitable food	Weight range in kg	Cookware or accessories, shelf height
Fresh vegetables <sup>1</sup>	Cauliflower, broccoli, carrots, kohlrabi, leeks, peppers, courgettes	0.20 – 1.00	Covered cookware Cooking compartment floor
Frozen vegetables <sup>1</sup>	Cauliflower, broccoli, carrots, kohlrabi, red cabbage, spinach	0.15 – 1.00	Covered cookware Cooking compartment floor
Baked potatoes	Waxy potatoes, predominantly waxy potatoes or floury potatoes, approx. 6 cm thick	0.20 – 2.00	Uncovered cookware Cooking compartment floor
Rice <sup>1</sup>	Rice, long-grain rice	0.10 – 0.50	Deep cookware with lid Cooking compartment floor
Fresh fish fillet	Fillet of pike, cod, ocean perch, pollock, pike-perch	0.20 – 1.00	Covered cookware Cooking compartment floor

<sup>1</sup> Observe the signals given when it is time to stir the food.

#### Combi cooking

Dish	Suitable food	Weight range in kg	Cookware or accessories, shelf height
Frozen pizza	Pizza with thin base, prebaked	0.15 – 0.55	Wire rack Position 3
Frozen lasagne	Lasagne bolognese	0.40 – 1.05	Uncovered cookware Cooking compartment floor
Fresh chicken <sup>1</sup>	Whole chicken	0.80 – 1.80	Covered cookware Cooking compartment floor

<sup>1</sup> Observe the signals given when it is time to turn the food.



Dish	Suitable food	Weight range in kg	Cookware or accessories, shelf height
Fresh chicken portions	Chicken thigh, half chicken	0.40 – 1.60	Covered cookware Cooking compartment floor
Meat loaf	Meat loaf, approx. 8 cm deep	0.80 – 1.50	Uncovered cookware Cooking compartment floor
Leg of lamb <sup>1</sup>	Leg of lamb or boneless shoulder of lamb	0.80 – 2.00	Uncovered cookware Cooking compartment floor

<sup>1</sup> Observe the signals given when it is time to turn the food.

## 14 Individual recipes

You can save, record or programme up to 50 individual recipes. You can name your recipes so that you can access them quickly and easily when needed.

### 14.1 Recording a recipe

You can set up to 5 phases one after the other and record these.

- Use the function selector to set the required microwave output setting or oven type of heating.
  - ✓ The display shows **W**.
- Press **W** and use the rotary selector to select "Individual recipes".
- Press **✓** to confirm.
- Use the rotary selector to select a free memory location.
- Press **rec**.
- Use the rotary selector to set the cooking time, temperature or grill setting.
- Press **▶** to start.
  - ✓ The appliance records the first phase and you can see the cooking time counting down. You can record an additional phase once the cooking time has elapsed. To end the phase early, press **■**.
- If required, select one of the options:
  - To save the recipe, press **↵** and enter a name under ABC.  
→ "Entering a name", Page 17
  - To cancel the recipe without saving, press **X**.
  - To continue the recording, carry out the following steps.
- Press **rec** to continue the recording.
- Use the function selector to set the required microwave output setting or type of heating.
- Use the rotary selector to set the cooking time, temperature or grill setting.
- Press **▶** to start.
  - ✓ For an oven type of heating, the appliance records the cooking time.
- Press **■** to end this phase.
  - ✓ The appliance saves this phase with the cooking time.
- If required, select one of the options:
  - To save the recipe, press **↵** and enter a name under ABC.  
→ "Entering a name", Page 17
  - To cancel the recipe without saving, press **X**.
  - To continue the recording, repeat the previous steps.

### Notes

- When you open the appliance door, the recording of the phase ends.
- You can operate the appliance in combined operation.  
→ "MicroCombi", Page 13



### 14.2 Programming a recipe

You can programme and save up to 5 phases for the preparation.





- Use the function selector to set the required microwave output setting or oven type of heating.
  - ✓ The display shows **W**.
- Press **W** and use the rotary selector to select "Individual recipes".
- Press **✓** to confirm.
- Use the rotary selector to select a free memory location.
- Press **↵**.
- Enter a name under "ABC". → Page 17
- Press **↵**.
- Use **➤** to select the first phase.
  - ✓ The appliance displays the type of heating. You can use the function selector to change the type of heating. Operation in combined operation is possible.  
→ Page 13
- Use the rotary selector to set the cooking time, temperature or grill setting.
- Select one of the following options:
  - Press **➤** to select the next phase.
  - Finish making entries once the preparation is complete.
- Select one of the following options:
  - Press **✓** to save.
  - To cancel without saving, press **X**.

### 14.3 Entering a name

- Enter a name for the recipe under "ABC".
- Use the rotary selector to select the letters.  
A new word always begins with a capital letter.  
Latin characters, certain special characters and numbers are available.
- Briefly press **➤A<sup>^</sup>** to position the cursor to the right.
- Press and hold **➤A<sup>^</sup>** to switch to umlauts and special characters.
- Press **➤A<sup>^</sup>** twice to insert a break.
- Briefly press **➤Ä** to position the cursor to the right.
- Press and hold **➤Ä** to switch to normal characters.
- Press **➤Ä** twice to insert a break.

9. Press  to delete a letter.
10. Select one of the following options:
  - Press  to save.
  - To cancel without saving, press **X**.







#### 14.4 Starting a recipe

1. Use the function selector to select any type of heating.
  - ✓ The display shows .
2. Press  and use the rotary selector to select "Individual recipes".
3. Press  to confirm.
4. Use the rotary selector to select the desired recipe.
5. Press  to start.
  - ✓ The operation starts and you can see the cooking time counting down.
  - ✓ The display shows the settings for the phases on the display bar.





**Note:** You can use the rotary selector to change the temperature and the grill setting for the oven type of heating, and to change the duration for the microwave output setting while the recipe is cooking. This does not change the saved recipe.

#### 14.5 Changing a recipe

You can change the settings of a recorded or programmed recipe.

1. Use the function selector to select any type of heating.
  - ✓ The display shows .
2. Press  and use the rotary selector to select "Individual recipes".
3. Press  to confirm.
4. Use the rotary selector to select the desired recipe.
5. Press .
6. Use  to select the required phase.
  - ✓ The display shows the settings. You can use the rotary selector or function selector to change the settings.
7. Select one of the following options:
  - Press  to save.
  - To cancel without saving, press **X**.

#### 14.6 Deleting a recipe



1. Use the function selector to select any type of heating.
  - ✓ The display shows .
2. Press  and use the rotary selector to select "Individual recipes".
3. Press  to confirm.
4. Use the rotary selector to select the desired recipe.
5. Use **C** to delete the recipe.
6. Press  to confirm.

## 15 Timer functions



Your appliance has different timer functions, with which you can control its operation.

### 15.1 Calling up the timer menu

#### Requirements

- The appliance is activated.
- The function selector is set to **0** or .
- ▶ Press .
- ✓ The timer menu is displayed.





#### Notes

- If you turn the function selector to a type of heating or basic settings **S** while the short-term timer or stop watch is running, a notification appears on the display. Press  to confirm the notification and interrupt the short-term timer or the stop watch. The appliance is ready to use.
- In order to continue the short-term timer or stop watch, turn the function selector to **0** or .
- You can use the short-term timer and the stopwatch at the same time.
- If the function selector is set to **0**, the display only shows the short-term timer.
- If the function selector is set to , the display shows the short-term timer and the stopwatch.

### 15.2 Short-term timer





The short-term timer only runs if you have not set any other function. You can enter a maximum of 90 minutes.

#### Set the short-term timer



1. Call up the timer menu.
  - ✓ The display shows "Timer" .
2. Use the rotary selector to set the required cooking time.
3. Press  to start.
  - ✓ The appliance closes the timer menu and the time counts down.
  - ✓ The display shows  and the time that has elapsed.
  - ✓ A signal tone sounds once the time has elapsed. If you press , you can end the signal early.

**Tip:** Press **X** to exit the timer menu. The settings are lost.

#### Stopping the short-term timer

1. Press .
2. Use  and "Timer" to select  and press **II**.
3. To allow the timer to continue counting down, press .

#### Switching off the timer early





1. Press .
2. Use  and "Timer" to select  and press **C**.

## 15.3 Stopwatch









The stopwatch only runs if you have not set any other function. The stopwatch counts upwards from 0 seconds up to 90 minutes.

You can use the pause function to pause the stopwatch occasionally.





### Starting the stopwatch

1. Press .
2. Use  to select "Stopwatch" .
3. Press  to start.
  - ✓ The appliance closes the timer menu and the time counts down.
  - ✓ The display shows  and the time that has elapsed.

### Stopping the stopwatch

1. Press .
2. Use  to select "Stopwatch" .
3. Press .
- ✓ The time stops and the symbol switches to start .
4. Press  to start the stopwatch.
  - ✓ The time continues to run. Once it has reached 90 minutes, the display pulses and a signal tone sounds. If you press , you can end the signal.
  - ✓  goes out on the display and the procedure is ended.

### Switching off the stopwatch

1. Press .
2. Use  to select "Stopwatch" .
3. Press .

## 15.4 Long-term timer

With this function, your appliance with the Hot air type of heating retains a temperature of 85 °C.









You can keep food warm for up to 74 hours without having to switch the appliance on or off.

Do not leave food which spoils easily in the oven for too long.

### Notes

- To use the long-term timer, you must set it to "available" in the basic settings.  
→ "Basic settings", Page 19
- If the short-term timer or the stopwatch is activated, you cannot select the long-term timer.

### Setting the long-term timer

1. Set the function selector to .
2. Press .
- ✓ The display shows the default value "24h" at 85 °C.
3. Press .
4. Use the rotary selector to set the required cooking time .
5. Press  to confirm.
6. Press  to start.
  - ✓ The appliance starts and the display shows  and the temperature.
  - ✓ The oven lighting and the display lighting are switched off.
  - ✓ The control panel is locked and the touch-key tones are deactivated.
  - ✓ When the time has elapsed, the appliance no longer heats up. Turn the function selector to .

### Switching off the long-term timer

- ▶ To cancel the transaction, turn the function selector to .



# 16 Childproof lock

You can secure your appliance to prevent children from accidentally switching it on or changing the settings.

## 16.1 Activating the childproof lock

### Requirements

- The childproof lock is set to "Available" in the basic settings.
- The function selector is set to .

- ▶ Press and hold  for approx. 6 seconds.
- ✓ The standby display appears and the display shows .

**Note:** If there is a power cut after the childproof lock has been activated, the childproof lock may be deactivated when the power comes back on.

## 16.2 Deactivating the childproof lock

**Requirement:** The function selector is set to .













- ▶ Press and hold  for approx. 6 seconds.

# 17 Basic settings









You can configure the basic settings for your appliance to meet your needs.

## 17.1 Overview of the basic settings

Here you can find an overview of the basic settings and factory settings. The basic settings depend on the features of your appliance.

Symbol	Basic setting	Settings	Explanation
	Brightness	<ul style="list-style-type: none"> <li>■ 1</li> <li>■ 2</li> <li>■ 3</li> <li>■ 4</li> <li>■ 5<sup>1</sup></li> <li>■ 6</li> <li>■ 7</li> <li>■ 8</li> </ul>	Set the display brightness.
	Standby screen	<ul style="list-style-type: none"> <li>■ On<sup>1</sup> <ul style="list-style-type: none"> <li>- Clock</li> <li>- Clock + GAGGENAU logo</li> <li>- Date</li> <li>- Date + GAGGENAU logo</li> <li>- Clock + date</li> <li>- Clock + date + GAGGENAU logo</li> </ul> </li> <li>■ Off</li> </ul>	Set the appearance of the standby screen. Off: You can use this setting to reduce the standby energy consumption of your appliance. On: You can set multiple displays. Use ✓ to confirm "On" and use the rotary selector to set the required display.
	Display	<ul style="list-style-type: none"> <li>■ Reduced<sup>1</sup></li> <li>■ Standard</li> </ul>	Reduced: After a short time, the display shows only the most important information.
	Touch field colour	<ul style="list-style-type: none"> <li>■ Grey<sup>1</sup></li> <li>■ White</li> </ul>	Set the colour of the symbols on the touch fields.
	Touch field tone type	<ul style="list-style-type: none"> <li>■ Tone 1<sup>1</sup></li> <li>■ Tone 2</li> <li>■ Off</li> </ul>	Set the signal tone when you touch a touch field.
	Touch field tone volume	<ul style="list-style-type: none"> <li>■ 1</li> <li>■ 2</li> <li>■ 3</li> <li>■ 4</li> <li>■ 5<sup>1</sup></li> <li>■ 6</li> <li>■ 7</li> <li>■ 8</li> </ul>	Set the volume of the touch field tone.
	Signal volume	<ul style="list-style-type: none"> <li>■ 1</li> <li>■ 2</li> <li>■ 3</li> <li>■ 4</li> <li>■ 5<sup>1</sup></li> <li>■ 6</li> <li>■ 7</li> <li>■ 8</li> </ul>	Set the volume of the signal tone.
	Heating-up time and heating-up signal	<ul style="list-style-type: none"> <li>■ Heating up with signal tone<sup>1</sup></li> <li>■ Rapid heating with signal tone</li> <li>■ Heating up without signal tone</li> <li>■ Rapid heating without signal tone</li> </ul>	When the appliance reaches the required temperature, the heating-up signal tone sounds. <b>Tip:</b> During rapid heating, the cooking compartment reaches the required temperature particularly quickly.
	Time format	<ul style="list-style-type: none"> <li>■ AM/PM</li> <li>■ 24 h<sup>1</sup></li> </ul>	Set the display of the time in the 12-hour or 24-hour format.
	Time	Current time	Set the time.
	Clock change	<ul style="list-style-type: none"> <li>■ Manual<sup>1</sup></li> <li>■ Automatic</li> </ul>	Automatic: The clock automatically adjusts to daylight saving time. For normal time and daylight savings time, set when you want the time to be converted.
	Date format	<ul style="list-style-type: none"> <li>■ D.M.Y<sup>1</sup></li> <li>■ D/M/Y</li> <li>■ M/D/Y</li> </ul>	Set the date format.
	Date	Current date	Set the current date. Press ➤ to switch between the year, month and day.



<sup>1</sup> Factory setting (may vary according to model)

Symbol	Basic setting	Settings	Explanation
	Temperature format	<ul style="list-style-type: none"> <li>■ °C<sup>1</sup></li> <li>■ °F</li> </ul>	Set the temperature format.
	Language	See selection on the appliance	Set the language for the text display. <b>Note:</b> When you change the language, the system restarts. This process takes a few seconds. The basic settings are then closed.
	Factory settings	Resetting the appliance to factory settings	<b>Notes</b> <ul style="list-style-type: none"> <li>■ Individual recipes are also deleted if the appliance is reset to factory settings.</li> <li>■ After restoring factory settings, the "Initial settings" menu is displayed.</li> </ul> To reset the appliance to the factory settings, use  to confirm. Press  to cancel.
	Demo mode	<ul style="list-style-type: none"> <li>■ On</li> <li>■ Off<sup>1</sup></li> </ul>	The demo mode is used for demonstration purposes only. The appliance does not heat up in demo mode but all other functions are available. Activate "Off" for normal mode. The setting is only possible in the first 3 minutes after connecting the appliance.
	Long-term timer	<ul style="list-style-type: none"> <li>■ Not available<sup>1</sup></li> <li>■ Available</li> </ul>	Available: The long-term timer is available. → "Long-term timer", Page 19
	Childproof lock	<ul style="list-style-type: none"> <li>■ Not available<sup>1</sup></li> <li>■ Available</li> </ul>	Available: The childproof lock is available. → "Childproof lock", Page 19

<sup>1</sup> Factory setting (may vary according to model)

## 17.2 Changing the basic settings

1. Turn the function selector to S.
2. Use the rotary selector to select the required basic setting.
3. Press .

4. Use the rotary selector to set the basic setting.
5. Use  to save or use  to cancel.
- ✓ The current initial setting is exited.
6. Turn the function selector to 0 to exit the basic settings menu.

# 18 Cleaning aid

## 18.1 Setting the cleaning aid

1. Add a few drops of washing-up liquid to a cup of water.
2. Place a spoon in the cup to prevent delayed boiling.
3. Place the cup in the centre of the cooking compartment.
4. Set the 600 W microwave output setting.

5. Set the cooking time to 5 minutes.
6. Start the operation.
7. Once the duration has elapsed, keep the door closed for a further 3 minutes.
8. Wipe out the cooking compartment with a soft cloth.
9. Leave the cooking compartment to dry with the door open.

# 19 Cleaning and servicing

To keep your appliance working efficiently for a long time, it is important to clean and maintain it carefully.

## 19.1 Cleaning products

Only use suitable cleaning agents.

### **WARNING – Risk of electric shock!**

An ingress of moisture can cause an electric shock.

- ▶ Do not use steam- or high-pressure cleaners to clean the appliance.

### **ATTENTION!**

Unsuitable cleaning agents damage the surfaces of the appliance.

- ▶ Do not use harsh or abrasive cleaning products.
- ▶ Do not use cleaning products with a high alcohol content.
- ▶ Do not use hard scouring pads or cleaning sponges.
- ▶ Do not use any special cleaners for cleaning the appliance while it is hot.
- ▶ Only use glass cleaners, glass scrapers or stainless steel care products if recommended in the cleaning instructions for the relevant part.

Salt contained in new sponge cloths may damage surfaces.

- ▶ Wash new sponge cloths thoroughly before use.

You can find out which cleaning products are suitable for each surface or part of the appliance in the individual cleaning instructions.

## 19.2 Cleaning the appliance

Clean the appliance as specified. This will ensure that the different parts and surfaces of the appliance are not damaged by incorrect cleaning or unsuitable cleaning products.

### **WARNING – Risk of burns!**

The appliance and its parts that can be touched become hot during use.

- ▶ Caution should be exercised here in order to avoid touching heating elements.
- ▶ Young children under 8 years of age must be kept away from the appliance.

### **WARNING – Risk of fire!**

Loose food remnants, fat and meat juices may catch fire.

- ▶ Before using the appliance, remove the worst of the food residues and remnants from the cooking compartment, heating elements and accessories.

### **WARNING – Risk of injury!**

Scratched glass in the appliance door may develop into a crack.

- ▶ Do not use any harsh or abrasive cleaners or sharp metal scrapers to clean the glass on the appliance door, as they may scratch the surface.

1. Read the information on cleaning products.  
→ Page 21
2. Observe the information on cleaning the appliance components or surfaces.
3. Unless otherwise specified:
  - Clean the components of the appliance with hot soapy water and a dish cloth.
  - Dry with a soft cloth.

## 19.3 Cleaning the front of the appliance

### **ATTENTION!**

Incorrect cleaning may damage the front of the appliance.

- ▶ Do not use glass cleaner, metal scrapers or glass scrapers for cleaning.
- ▶ To prevent corrosion on stainless steel fronts, remove any limescale, grease, starch and albumin (e.g. egg white) stains immediately.
- ▶ On stainless steel surfaces, use special stainless steel cleaning products suitable for hot surfaces.

1. Read the information on cleaning products.  
→ Page 21
2. Clean the front of the appliance using hot soapy water and a dish cloth.

**Note:** Slight differences in colour on the front of the appliance are caused by the use of different materials, such as glass, plastic and metal.

3. For stainless steel appliance fronts, apply a thin layer of the stainless steel cleaning product with a soft cloth.  
You can obtain the stainless steel cleaning products from the after-sales service or the online shop.
4. Dry with a soft cloth.

## 19.4 Cleaning aluminium

1. Clean using a mild window-cleaning product.
2. Using a window cloth or a non-fluffing microfibre cloth, wipe over the surfaces lightly in a horizontal direction.

## 19.5 Cleaning the cooking compartment

### **ATTENTION!**

Incorrect cleaning may damage the cooking compartment.

- ▶ Do not use oven spray, abrasive materials or other aggressive oven cleaners.

### **Note:**

In the event of extremely heavy soiling, use oven cleaner gel (order number 00311859 from customer service or from the online shop).

- Do not touch seals on the door or bulb
  - Leave for no more than 12 hours
  - Do not use it on hot surfaces
  - Rinse off thoroughly with water
  - Observe the manufacturer's instructions
1. Read the information on cleaning products.  
→ Page 21
  2. Clean with hot soapy water or a vinegar solution.
  3. Use an oven cleaner that is suitable for stainless steel surfaces to remove very heavy soiling.  
Only use oven cleaner when the cooking compartment is cold.  
**Tip:** To eliminate unpleasant odours, heat up a cup of water with a few drops of lemon juice for 1 to 2 minutes at maximum microwave output setting. Always place a spoon in the container to prevent delayed boiling.
  4. Wipe out the cooking compartment with a soft cloth.
  5. Leave the cooking compartment to dry with the door open.

## 19.6 Cleaning the control panel

### **ATTENTION!**

Incorrect cleaning may damage the control panel.

- ▶ Never wipe the control panel with a wet cloth.

1. Read the information on cleaning products.  
→ Page 21
2. Clean the control panel using a microfibre cloth or a soft, damp cloth.
3. Dry with a soft cloth.

## 19.7 Cleaning the door panels

### **ATTENTION!**

Incorrect cleaning may damage the door panes.

- ▶ Do not use a glass scraper.

1. Read the information on cleaning products.  
→ Page 21

2. Clean the door panels with a soft dish cloth and glass cleaner.  
**Note:** Shadows on the door panels, which look like streaks, are caused by reflections made by the interior lighting.
3. Dry with a soft cloth.

## 19.8 Cleaning the door seal

Do not remove the door seal.

### ATTENTION!

Incorrect cleaning may damage the door seal.

- ▶ Do not use metal scrapers or glass scrapers for cleaning.
  - ▶ Do not use abrasive cleaning agents.
1. Read the information on cleaning products.  
→ Page 21
  2. Clean the door seal with hot soapy water and a soft dish cloth.
  3. Dry with a soft cloth.

## 19.9 Cleaning the accessories

1. Read the information on cleaning products.  
→ Page 21
2. Soften baked-on food remnants with a damp dish cloth and hot soapy water.
3. Clean the accessory with hot soapy water and a soft dish cloth or a scrubbing brush.
4. Clean the wire rack with stainless steel cleaner or in the dishwasher.  
Use steel wool or oven cleaner to remove very heavy soiling.
5. Dry with a soft cloth.

## 19.10 Cleaning the glass cover

The glass cooking compartment light cover is located on the left side wall inside the cooking compartment.

### ⚠ WARNING – Risk of burns!

The glass cover for the cooking compartment light becomes hot.

- ▶ Only hold the glass cover when you are wearing heat-resistant gloves.

1. Undo the screw on the glass cover.
2. Clean the glass using a detergent solution.
3. Screw in the glass cover.

## 19.11 Cleaning self-cleaning surfaces

The rear panel of the cooking compartment has a self-cleaning, catalytic coating. This coating absorbs and dispels splashes from baking and roasting while the appliance is in operation.

### ATTENTION!

Using oven cleaner on the self-cleaning surfaces damages the surfaces.

- ▶ Do not use oven cleaner on the self-cleaning surfaces. If oven cleaner does get onto these surfaces, dab it off immediately using water and a sponge cloth. Do not rub the surface and do not use abrasive cleaning aids.

**Requirement:** The cooking compartment has cooled down.

- ▶ Brownish or whitish residues can be removed with water and a soft sponge.

**Note:** During operation, reddish spots form on the surfaces. This is not rust, but residues from food. These spots are not harmful and do not impair the cleaning ability of the self-cleaning surfaces.

## 19.12 Replacing the cooking compartment bulb

If the cooking compartment light has failed, replace the cooking compartment bulb.

**Note:** Heat-resistant, 60 W, 240 V halogen bulbs are available from customer service or specialist retailers. Only use these bulbs. Hold the new halogen bulbs only with a clean, dry towel. This increases the service life of the bulb.

### ⚠ WARNING – Risk of burns!

The appliance and its parts that can be touched become hot during use.

- ▶ Caution should be exercised here in order to avoid touching heating elements.
- ▶ Young children under 8 years of age must be kept away from the appliance.

### ⚠ WARNING – Risk of electric shock!

When changing the bulb, the bulb socket contacts are live.

- ▶ Before replacing the bulb, ensure that the appliance is switched off in order to prevent a potential electric shock.
- ▶ Also unplug the appliance from the mains or switch off the circuit breaker in the fuse box.

### Requirements

- The cooking compartment has cooled down.
  - The new halogen bulb to replace the old one is available.
1. Disconnect the appliance from the mains power supply.
  2. Remove the appliance.  
→ "Installation instructions", Page 37
    - Open the appliance door.
    - Undo the fastening screws on the right- and left-hand side of the oven.
    - Carefully lift out the appliance.

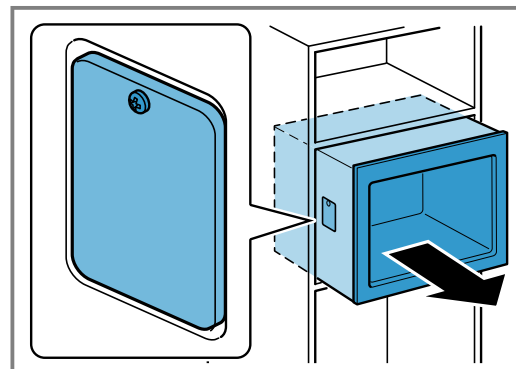

3. Undo the screw from the bulb cover on the left-hand, outer side wall and remove the bulb cover.

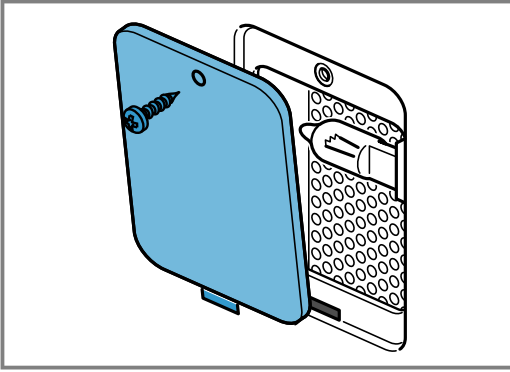

4. Pull out the halogen bulb.

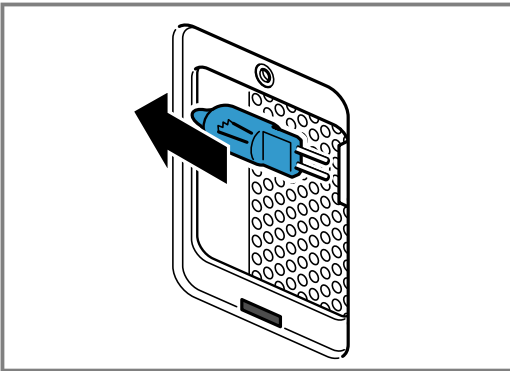

5. Insert the new halogen bulb.

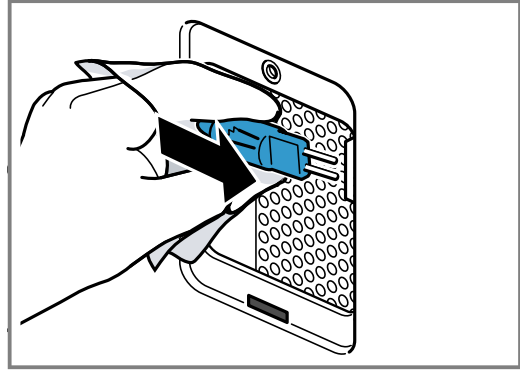

6. Screw the lamp cover in place.  
 7. Install the appliance.  
 – Carefully slide in the appliance.  
 – Tighten the fastening screws on the right and left-hand side of the oven.  
 – Close the appliance door.  
 8. Connect the appliance to the power supply.

### 19.13 Replacing the glass cover

If the glass cover in the cooking compartment is damaged, it must be replaced.

**Note:** Suitable glass covers are available from customer service.

#### Requirements

- The cooking compartment has cooled down.
  - The new glass cover to replace the old one is available.
1. Undo the screw from the glass cover.
  2. Screw in the new glass cover.

## 20 Troubleshooting

You can rectify minor faults on your appliance yourself. Read the troubleshooting information before contacting after-sales service. This will avoid unnecessary costs.

### **⚠ WARNING – Risk of injury!**

Improper repairs are dangerous.

- ▶ Repairs to the appliance should only be carried out by trained specialist staff.
- ▶ If the appliance is defective, call Customer Service.  
 → "Customer Service", Page 26

### **⚠ WARNING – Risk of electric shock!**



Incorrect repairs are dangerous.

- ▶ Repairs to the appliance should only be carried out by trained specialist staff.
- ▶ Only use genuine spare parts when repairing the appliance.
- ▶ If the power cord of this appliance is damaged, it must be replaced by the manufacturer, the manufacturer's Customer Service or a similarly qualified person in order to prevent any risk.

### 20.1 Malfunctions

Fault	Cause and troubleshooting
The appliance is not working.	The mains plug of the power cord is not plugged in. ▶ Connect the appliance to the power supply.
	The circuit breaker in the fuse box has tripped. ▶ Check the circuit breaker in the fuse box.
	There has been a power cut. ▶ Check whether the lighting in your kitchen or other appliances are working.



Fault	Cause and troubleshooting
The appliance is not working.	<p>Malfunction</p> <ol style="list-style-type: none"> <li>1. Switch off the fuse in the fuse box.</li> <li>2. Switch the fuse on after approx. 10 seconds.</li> <li>3. If the malfunction occurs again, call customer service.</li> </ol>
Appliance does not start.	<p>Appliance door not fully closed.</p> <ul style="list-style-type: none"> <li>▶ Close appliance door.</li> </ul>
Food takes longer than usual to heat up.	<p>The microwave power setting is set too low.</p> <ul style="list-style-type: none"> <li>▶ Set a higher microwave output setting. → <i>"Microwave"</i>, Page 11</li> </ul> <p>A larger amount than usual has been placed in the appliance.</p> <ul style="list-style-type: none"> <li>▶ Set a longer cooking time. You need double the time when you have double the amount.</li> </ul> <p>The food is colder than usual.</p> <ul style="list-style-type: none"> <li>▶ Turn or stir the food from time to time during cooking.</li> </ul>
Appliance is switched on but controls not responding;  appears on the display.	<p>Childproof lock is activated.</p> <ul style="list-style-type: none"> <li>▶ Deactivate the childproof lock. → <i>"Deactivating the childproof lock"</i>, Page 19</li> </ul>
The appliance is not heating and  appears on the display.	<p>Demo mode is activated.</p> <ul style="list-style-type: none"> <li>▶ Deactivate demo mode. → <i>"Basic settings"</i>, Page 19</li> </ul>
The interior lighting is not working.	<p>The halogen bulb is defective.</p> <ul style="list-style-type: none"> <li>▶ Change the cooking compartment bulb. → <i>"Replacing the cooking compartment bulb"</i>, Page 23 You can obtain a new halogen bulb from our customer service or specialist retailers. → <i>"Customer Service"</i>, Page 26</li> </ul>

## 20.2 Information on display panel

Fault	Cause and troubleshooting
The display shows the error message "Exxx"	<p>An error has occurred.</p> <ol style="list-style-type: none"> <li>1. Switch the appliance off and on again. ✓ If the fault was a one-off, the message disappears.</li> <li>2. If the message appears again, call the after-sales service. Please specify the exact error message when calling. → <i>"Customer Service"</i>, Page 26</li> </ol>

## 20.3 Power cut

Your appliance can bridge a power cut of a few seconds. The operation continues. If the power cut lasts longer and the appliance was operating, the display shows a message. The operation is interrupted. After the power cut, you can start up the

appliance as usual. To do so, turn the function selector to the zero position.  
→ *"Initial start-up"*, Page 10

# 21 Disposal

## 21.1 Disposing of old appliance

Valuable raw materials can be reused by recycling.

- ▶ Dispose of the appliance in an environmentally friendly manner. Information about current disposal methods are available from your specialist dealer or local authority.



This appliance is labelled in accordance with European Directive 2012/19/EU concerning used electrical and electronic appliances (waste electrical and electronic equipment - WEEE).

The guideline determines the framework for the return and recycling of used appliances as applicable throughout the EU.

## 22 Customer Service

Detailed information on the warranty period and terms of warranty in your country is available from our after-sales service, your retailer or on our website.

If you contact Customer Service, you will require the product number (E-Nr.) and the production number (FD) of your appliance.

The contact details for Customer Service can be found in the enclosed Customer Service directory or on our website.

This product contains light sources from energy efficiency class G.

### 22.1 Product number (E-Nr.) and production number (FD)

You can find the product number (E-Nr.) and the production number (FD) on the appliance's rating plate. You will see the rating plate with these numbers if you open the appliance door.

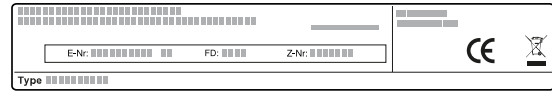

Make a note of your appliance's details and the Customer Service telephone number to find them again quickly.

## 23 How it works

Here, you can find the ideal settings for various dishes as well as the best accessories and cookware. We have tailored these recommendations to your appliance.

### 23.1 What is the best way to proceed?

In this section, you will find out the best way to proceed using step-by-step instructions to make optimal use of the recommended settings. You will get information on many meals, with details and tips on how to best use and set your appliance.

#### Tip

Cooking tips

- The recommended settings always apply to the cooking compartment when it is cold and empty.
- The times specified in the overviews are intended as a guide only. They will depend on the quality and composition of the food.

#### **⚠ WARNING – Risk of scalding!**

Hot liquid may spill over the sides of the accessory when it is removed from the cooking compartment.

- ▶ Remove hot accessories with care and always wear oven gloves.

1. Before using the appliance, remove all unnecessary cookware from the cooking compartment.
2. Select the desired food from the recommended settings.

### Defrosting with the microwave

#### Note:

Cooking tips

- Freeze the food flat.
- Use microwave-safe cookware without a lid.
- Place the cookware on the bottom of the cooking compartment.
- Turn or stir the food 2 to 3 times during this time. When turning, remove any liquid that escapes during defrosting.
- Liquid is produced when defrosting meat or poultry. When turning, drain off any liquid. Do not continue to use this for other purposes or allow it to come into contact with other foods.
- After turning, remove any minced meat that has already defrosted.
- Separate any defrosted parts when turning.

3. Place the food in suitable cookware.
4. Place the cookware in the middle on the cooking compartment floor.  
The food can then absorb the microwaves from all sides.
5. Use the recommended settings when configuring the appliance settings.  
Set the shorter cooking time first. If necessary, increase the cooking time.
6. Use an oven cloth or oven gloves when taking hot cookware out of the cooking compartment.

### 23.2 Defrosting

With your appliance you can defrost frozen food.

#### Tips on defrosting, heating and cooking with the microwave

Follow these tips for good results when defrosting, heating and cooking with the microwave.

Issue	Tip
You want to prepare a different amount than that indicated in the table.	Increase or reduce the cooking times using the following rule of thumb: <ul style="list-style-type: none"> <li>■ Double the amount = almost double the cooking time</li> <li>■ Half the amount = half the cooking time</li> </ul>

- Delicate parts such as the legs and wings of chicken or fatty outer layers of roasts can be covered with small pieces of aluminium foil. The foil must not touch the walls of the appliance. Remove the foil half-way through the defrosting time.
- To allow the temperature to equalise, leave the defrosted food to rest for another 10 to 60 minutes in the appliance after switching it off. You can remove the giblets from poultry at this point.

<b>Food</b>	<b>Weight</b>	<b>Microwave output setting</b>	<b>Duration</b>
Whole pieces of meat, on the bone or boned	800 g	1. 180 W 2. 90 W	1. 15 mins <sup>1</sup> 2. 15 – 25 mins
Whole pieces of meat, on the bone or boned	1000 g	1. 180 W 2. 90 W	1. 15 mins <sup>1</sup> 2. 25 – 35 mins
Whole pieces of meat, on the bone or boned	1500 g	1. 180 W 2. 90 W	1. 20 mins <sup>1</sup> 2. 25 – 35 mins
Meat in pieces or slices	200 g	1. 180 W 2. 90 W	1. 5 mins <sup>2</sup> 2. 4 – 6 mins
Meat in pieces or slices	500 g	1. 180 W 2. 90 W	1. 10 mins <sup>2</sup> 2. 5 – 10 mins
Meat in pieces or slices	800 g	1. 180 W 2. 90 W	1. 10 mins <sup>2</sup> 2. 10 – 15 mins
Minced meat, mixed	200 g	90 W	15 mins <sup>1</sup>
Minced meat, mixed	500 g	1. 180 W 2. 90 W	1. 5 mins <sup>1</sup> 2. 10 – 15 mins
Minced meat, mixed	800 g	1. 180 W 2. 90 W	1. 10 mins <sup>1</sup> 2. 15 – 20 mins
Poultry or poultry portions	600 g	1. 180 W 2. 90 W	1. 5 mins <sup>1</sup> 2. 10 – 15 mins
Poultry or poultry portions	1200 g	1. 180 W 2. 90 W	1. 10 mins <sup>1</sup> 2. 20 – 25 mins
Duck	2000 g	1. 180 W 2. 90 W	1. 20 mins <sup>1</sup> 2. 30 – 40 mins
Goose	4500 g	1. 180 W 2. 90 W	1. 30 mins <sup>1</sup> 2. 60 – 80 mins
Fish fillet, fish steak or fish slices	400 g	1. 180 W 2. 90 W	1. 5 mins 2. 10 – 15 mins
Whole fish	300 g	1. 180 W 2. 90 W	1. 3 mins <sup>1</sup> 2. 10 – 15 mins
Whole fish	600 g	1. 180 W 2. 90 W	1. 8 mins <sup>1</sup> 2. 15 – 25 mins
Vegetables, e.g. peas	300 g	180 W	10 – 15 mins <sup>3</sup>
Vegetables, e.g. peas	600 g	1. 180 W 2. 90 W	10 mins <sup>3</sup> 2. 8 – 13 mins
Fruit, e.g. raspberries	300 g	180 W	7 – 10 mins <sup>3</sup>
Fruit, e.g. raspberries	500 g	1. 180 W 2. 90 W	1. 8 mins <sup>3</sup> 2. 5 – 10 mins
Butter, defrosting <sup>4</sup>	125 g	90 W	6 – 8 mins
Butter, defrosting <sup>4</sup>	250 g	1. 180 W 2. 90 W	1. 2 mins 2. 3 – 5 mins
Loaf of bread	500 g	1. 180 W 2. 90 W	1. 3 mins <sup>1</sup> 2. 10 – 15 mins
Loaf of bread	1000 g	1. 180 W 2. 90 W	1. 5 mins <sup>1</sup> 2. 15 – 25 mins
Cakes, plain, e.g. sponge cake <sup>5, 6</sup>	500 g	90 W	10 – 15 mins

<sup>1</sup> Turn the food several times.

<sup>2</sup> Separate any defrosted parts when turning.

<sup>3</sup> Carefully stir the food occasionally.

<sup>4</sup> Remove all packaging.

<sup>5</sup> Only defrost cakes without icing, whipped cream, gelatine or custard.

<sup>6</sup> Separate the pieces of cake.

Food	Weight	Microwave output setting	Duration
Cakes, plain, e.g. sponge cake <sup>5,6</sup>	750 g	1. 180 W 2. 90 W	1. 3 mins 2. 10 – 15 mins
Cakes, moist, e.g. fruit flan, cheesecake <sup>5</sup>	500 g	1. 180 W 2. 90 W	1. 5 mins 2. 15 – 25 mins
Cakes, moist, e.g. fruit flan, cheesecake <sup>5</sup>	750 g	1. 180 W 2. 90 W	1. 7 mins 2. 15 – 25 mins

- <sup>1</sup> Turn the food several times.  
<sup>2</sup> Separate any defrosted parts when turning.  
<sup>3</sup> Carefully stir the food occasionally.  
<sup>4</sup> Remove all packaging.  
<sup>5</sup> Only defrost cakes without icing, whipped cream, gelatine or custard.  
<sup>6</sup> Separate the pieces of cake.

### Tips on defrosting, heating and cooking with the microwave next time

Follow these tips for good results when defrosting, heating and cooking with the microwave.

Issue	Tip
Your food is too dry.	<ul style="list-style-type: none"> <li>▪ Reduce the cooking time or select a lower microwave power setting.</li> <li>▪ Cover the food and add more liquid.</li> </ul>

Issue	Tip
The time has elapsed but the food is not defrosted, hot or cooked.	Increase the cooking time. Large quantities and food which is piled high require longer times.
The time has elapsed but your food is not yet done on the inside, but is already overdone on the outside.	<ul style="list-style-type: none"> <li>▪ Stir occasionally.</li> <li>▪ Reduce the microwave power setting and increase the cooking time.</li> </ul>
After defrosting, the poultry or meat is defrosted on the outside but not defrosted in the middle.	<ul style="list-style-type: none"> <li>▪ Reduce the microwave power setting.</li> <li>▪ Turn large pieces of frozen food several times.</li> </ul>

## 23.3 Heating

With your appliance you can heat food.

### Heating up or cooking frozen food with the microwave

Observe the recommended settings for using the microwave to heat food.

#### Note:

Cooking tips

- Use microwave-safe cookware with a lid. You can also use a plate or a microwave cover to cover the dish. Take ready meals out of the packaging.
- Distribute the food flat in the cookware. Food which lies flat cooks more quickly than food which is piled high.
- Place the cookware on the bottom of the cooking compartment.
- The food transfers heat to the cookware. The cookware can become very hot. Use oven gloves.
- Turn or stir the food 2 to 3 times during this time.
- After heating, leave the food to rest for 2 to 5 minutes.
- The food will retain most of its natural flavor. Use salt and seasonings sparingly.

Food	Weight	Microwave output setting	Duration
Set menu, plated meal, ready meal with 2–3 components	300 – 400 g	600 W	11 – 15 mins
Soup	400 – 500 g	600 W	8 – 13 mins
Stews	500 g	600 W	10 – 15 mins
Stews	1000 g	600 W	20 – 25 mins
Slices or pieces of meat in sauce, e.g. goulash	500 g	600 W	12 – 17 mins
Slices or pieces of meat in sauce, e.g. goulash	1000 g	600 W	25 – 30 mins

- <sup>1</sup> Add a little liquid to the food.  
<sup>2</sup> Cook the food without any additional water.

Food	Weight	Microwave output setting	Duration
Fish, e.g. fillet steaks	400 g	600 W	10 – 15 mins
Fish, e.g. fillet steaks	800 g	600 W	20 – 25 mins
Side dishes, e.g. rice, pasta <sup>1</sup>	250 g	600 W	2 – 5 mins
Side dishes, e.g. rice, pasta <sup>1</sup>	500 g	600 W	8 – 10 mins
Vegetables, e.g. peas, broccoli, carrots <sup>1</sup>	300 g	600 W	8 – 10 mins
Vegetables, e.g. peas, broccoli, carrots <sup>1</sup>	600 g	600 W	14 – 17 mins
Creamed spinach <sup>2</sup>	450 g	600 W	11 – 16 mins

<sup>1</sup> Add a little liquid to the food.

<sup>2</sup> Cook the food without any additional water.

### Heating food in the microwave

Observe the recommended settings for using the microwave to heat food.

#### **⚠ WARNING – Risk of scalding!**

There is a possibility of delayed boiling when a liquid is heated. This means that the liquid reaches the boiling temperature without the usual steam bubbles rising to the surface. Exercise caution even when only gently shaking the container. The hot liquid may suddenly boil over and splatter.

- ▶ Always place a spoon in the container when heating liquids. This prevents delayed boiling.

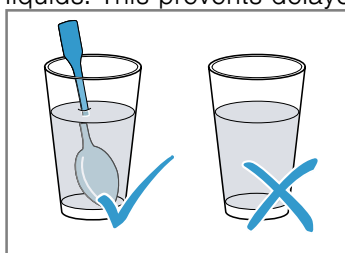

#### **ATTENTION!**

Metal touching the wall of the cooking compartment will cause sparks, which may damage the appliance or the inner door pane.

- ▶ Metal (e.g. a spoon in a glass) must be kept at least 2 cm from the cooking compartment walls and the inside of the door.

#### **Note:**

Cooking tips

- Use microwave-safe cookware with a lid. You can also use a plate or a microwave cover to cover the dish. Take ready meals out of the packaging.
- Place the cookware on the bottom of the cooking compartment.
- Turn or stir the food 2 to 3 times during this time.
- After heating, leave the food to rest for 2 to 5 minutes.
- The food transfers heat to the cookware. The cookware can become very hot. Use oven gloves.

Food	Weight	Microwave output setting	Duration
Set menu, plated meal, ready meal with 2–3 components	350 – 500 g	600 W	4 – 8 mins
Drinks <sup>1, 2, 3</sup>	150 ml	1000 W	1 – 2 mins
Drinks <sup>1, 2, 3</sup>	300 ml	1000 W	2 – 3 mins
Drinks <sup>1, 2, 3</sup>	500 ml	1000 W	4 – 5 mins
Baby food, e.g. baby bottles <sup>4, 5, 6</sup>	50 ml	360 W	0:30 – 1 min.
Baby food, e.g. baby bottles <sup>4, 5, 6</sup>	100 ml	360 W	0:30 – 1:30 mins
Baby food, e.g. baby bottles <sup>4, 5, 6</sup>	200 ml	360 W	1 – 2 mins
Soup, 1 cup	175 g each	600 W	2 – 3 mins
Soup, 2 cups	175 g each	600 W	3 – 4 mins
Soup, 4 cups	175 g each	600 W	6 – 8 mins
Meat in sauce <sup>7</sup>	500 g	600 W	8 – 11 mins
Stew	400 g	600 W	6 – 8 mins
Stew	800 g	600 W	8 – 11 mins

<sup>1</sup> Place a spoon in the glass.

<sup>2</sup> Do not overheat alcoholic drinks.

<sup>3</sup> Check the food occasionally.

<sup>4</sup> Heat up baby food without the teat or lid.

<sup>5</sup> Always shake the food well after heating.

<sup>6</sup> Always check the temperature.

<sup>7</sup> Cover the food.

<sup>8</sup> Add a little liquid to the food.

Food	Weight	Microwave output setting	Duration
Vegetables, 1 portion <sup>8</sup>	150 g	600 W	2 – 3 mins
Vegetables, 2 portions <sup>8</sup>	300 g	600 W	3 – 5 mins

<sup>1</sup> Place a spoon in the glass.

<sup>2</sup> Do not overheat alcoholic drinks.

<sup>3</sup> Check the food occasionally.

<sup>4</sup> Heat up baby food without the teat or lid.

<sup>5</sup> Always shake the food well after heating.

<sup>6</sup> Always check the temperature.

<sup>7</sup> Cover the food.

<sup>8</sup> Add a little liquid to the food.

## 23.4 Cooking

With your appliance you can cook food.

### Cooking with the microwave

#### Note:

Cooking tips

- Use microwave-safe cookware with a lid. You can also use a plate or a microwave cover to cover the dish. Take ready meals out of the packaging.
- Distribute the food flat in the cookware. Food which lies flat cooks more quickly than food which is piled high.
- Place the cookware on the bottom of the cooking compartment.
- The food transfers heat to the cookware. The cookware can become very hot. Use oven gloves.
- After heating, leave the food to rest for 2 to 5 minutes.
- The food will retain most of its natural flavor. Use salt and seasonings sparingly.

Food	Weight	Microwave output setting	Duration
Whole chicken, fresh, without giblets <sup>1</sup>	1200 g	600 W	25 – 30 mins
Fish fillet, fresh	400 g	600 W	7 – 12 mins
Vegetables, fresh <sup>2, 3, 4</sup>	250 g	600 W	6 – 10 mins
Vegetables, fresh <sup>2, 3, 4</sup>	500 g	600 W	10 – 15 mins
Potatoes <sup>2, 3, 4</sup>	250 g	600 W	8 – 10 mins
Potatoes <sup>2, 3, 4</sup>	500 g	600 W	12 – 15 mins
Potatoes <sup>2, 3, 4</sup>	750 g	600 W	15 – 22 mins
Rice <sup>5</sup>	125 g	1. 600 W 2. 180 W	1. 4 – 6 mins 2. 12 – 15 mins
Rice <sup>5</sup>	250 g	1. 600 W 2. 180 W	1. 6 – 8 mins 2. 15 – 18 mins
Desserts, e.g. blancmange (instant) <sup>4</sup>	500 ml	600 W	5 – 8 mins
Fruit, compote <sup>4</sup>	500 g	600 W	9 – 12 mins

<sup>1</sup> Turn the dish halfway through the cooking time.

<sup>2</sup> Cut into pieces of equal size.

<sup>3</sup> Add a little water to the food.

<sup>4</sup> Carefully stir the food occasionally.

<sup>5</sup> Add double the amount of liquid.

### Blancmange made from blancmange powder

#### WARNING – Risk of burns!

Heated food gives off heat. The cookware may become hot.

- ▶ Always use oven gloves to remove cookware or accessories from the cooking compartment.

1. Mix together one packet of blancmange powder with sugar and a little milk in a tall microwave-suitable bowl in accordance with the package instructions so that there are no lumps.
2. Add the rest of the milk and stir again.
3. Place the bowl into the cooking compartment and close the appliance door.
4. Set the appliance according to the recommended settings.

5. Only stir for the first time after 3 minutes. Then stir again every minute until it reaches the required consistency.  
The cooking time depends on the temperature of the milk and the container that is used.

## 23.5 Cakes and baked items

Recommended settings for cakes and baked items. The temperature and baking time depend on the consistency and quantity of the dough. This is why temperature ranges are given in the tables. Begin with the lower temperature and, if necessary, use a higher setting the next time. A lower temperature results in more even browning.

### Baking tips

We have compiled a few tips to help you achieve a good baking result.

Issue	Tip
You want your cake to rise evenly.	<ul style="list-style-type: none"> <li>▪ Only grease the base of the springform cake tin.</li> <li>▪ After baking, use a knife to carefully loosen the cake from the baking tin.</li> </ul>

Issue	Tip
You do not want small baked items to stick to each other when baking.	Leave a minimum clearance of 2 cm around each item to be baked. This allows enough space for the baked items to expand and brown on all sides.
Determine whether the cake is ready.	Push a cocktail stick into the highest point on the cake. If no dough sticks to the wood, the cake is ready.
You want to bake using your own recipe.	Use similar items in the baking tables as a guide.
Use bakeware made of silicone, glass, plastic or ceramic.	<ul style="list-style-type: none"> <li>▪ The bakeware must be heat-resistant up to 250 °C.</li> <li>▪ Cakes in this bakeware brown less.</li> <li>▪ When using the microwave, the cooking time is shorter than the time shown in the table.</li> </ul>

### Cakes and other baked goods

Note the recommended settings for cakes and baked items.

#### Note:

Cooking tips

- Always place the cake tin in the centre of the wire rack.
- Dark-coloured metal baking tins are most suitable.
- Metal baking tins are not suitable for baking with microwaves.
- For the combination with microwave, use baking tins made of glass, ceramic or plastic. These must be heat-resistant up to 250 °C.
- The temperature and baking time depend on the consistency and quantity of the dough. This is why temperature ranges are given in the tables. Begin with the lowest temperature and, if necessary, use a higher setting the next time. A lower temperature results in more even browning.
- The times given apply to food placed in a cold oven.

Food	Cookware	Position	Microwave output setting	Type of heating	Temperature	Duration
Sponge cake, simple	Bundt tin, ring tin or loaf tin	1		✦	160 – 170 °C	60 – 80 mins
Sponge cake, delicate, e.g. sand cake	Bundt tin, ring tin or loaf tin	1		✦	150 – 160 °C	60 – 70 mins
Sponge flan base with edge of short-crust pastry	Springform tin	1		✦	160 – 170 °C	35 – 45 mins
Sponge flan base	Flan tin	1		✦	160 – 170 °C	35 – 45 mins
Sponge flan (hot water sponge cake)	Springform tin	1		✦	170 – 180 °C	45 – 50 mins
Cake with dry topping (sponge)	Glass tray	2		✦	160 – 170 °C	35 – 50 mins
Cake with moist topping, e.g. yeast dough with apple crumble	Glass tray	2		✦	155 – 165 °C	55 – 65 mins

<sup>1</sup> Allow cakes to cool in the oven for approx. 20 minutes.

Food	Cookware	Position	Microwave output setting	Type of heating	Temperature	Duration
Plaited loaf with 500 g flour	Glass tray	2		✦	160 – 170 °C	30 – 40 mins
Stollen with 500 g flour	Glass tray	2		✦	170 – 180 °C	60 – 70 mins
Pizza	Glass tray	2		✦	200 – 210 °C	30 – 40 mins
Yeast bread, 1 kg	Glass tray	2		✦	180 – 190 °C	50 – 60 mins
Nut cake	Springform tin	1	90 W	✦	170 – 180 °C	30 – 35 mins
Fruit tart or cheesecake with shortcrust pastry	Springform tin	2	360 W	✦	150 – 160 °C	40 – 50 mins <sup>1</sup>
Fruit pie, delicate with sponge	Springform cake tin or ring cake tin	1	90 W	✦	170 – 190 °C	30 – 45 mins
Savoury bakes, e.g. quiche or onion tart	Springform cake tin or quiche tin	2	90 W	✦	160 – 180 °C	50 – 70 mins

<sup>1</sup> Allow cakes to cool in the oven for approx. 20 minutes.

### Small baked items

Food	Cookware	Position	Type of heating	Temperature	Duration
Biscuits	Glass tray	2	✦	150 – 170 °C	20 – 35 mins
Meringues	Glass tray	2	✦	110 °C	90 – 120 mins
Macaroons	Glass tray	2	✦	110 °C	35 – 45 mins
Puff pastry	Glass tray	2	✦	180 – 200 °C	35 – 45 mins
Bread rolls, e.g. rye bread rolls	Glass tray	2	✦	180 – 200 °C	25 – 45 mins

### Tips for next time you bake

If something goes wrong when baking, you can find some tips here.

Issue	Tip
Your cake collapses.	<ul style="list-style-type: none"> <li>Note the ingredients and preparation instructions that are given in the recipe.</li> <li>Use less liquid.</li> </ul> <p>Or:</p> <ul style="list-style-type: none"> <li>Reduce the baking temperature by 10 °C and increase the baking time.</li> </ul>
Your cake is too dry.	Increase the baking temperature by 10 °C and shorten the baking time.
Your cake is generally too light in colour.	<ul style="list-style-type: none"> <li>Check the shelf position and accessory.</li> <li>Increase the baking temperature by 10 °C.</li> </ul> <p>Or:</p> <ul style="list-style-type: none"> <li>Increase the baking time.</li> </ul>
Your whole cake is too dark.	Reduce the baking temperature and increase the baking time.
Your cake is too light on top and too dark underneath.	Place the cake one level higher in the cooking compartment.

Issue	Tip
Your cake is too dark on top and too light underneath.	<ul style="list-style-type: none"> <li>Place the cake one level lower in the cooking compartment.</li> <li>Reduce the baking temperature and increase the baking time</li> </ul>
Your cake is unevenly browned.	<ul style="list-style-type: none"> <li>Reduce the baking temperature.</li> <li>Cut the greaseproof paper to a suitable size.</li> <li>Position the baking tin in the centre.</li> <li>Shape small baked goods to be the same size and thickness.</li> </ul>
Your cake is cooked on the outside but is not fully baked through on the inside.	<ul style="list-style-type: none"> <li>Reduce the baking temperature and increase the baking time.</li> <li>Add less liquid.</li> </ul> <p>For cakes with a moist topping:</p> <ul style="list-style-type: none"> <li>Pre-bake the base.</li> <li>Sprinkle the baked base with almonds or breadcrumbs.</li> <li>Place the topping on the base.</li> </ul>



Issue	Tip
The cake will not come out of the tin when turned upside down.	<ul style="list-style-type: none"> <li>■ Allow the cake to cool for 5 - 10 minutes after baking.</li> <li>■ Use a knife to carefully loosen the edge of the cake.</li> <li>■ Turn the cake tin upside down again and cover it several times with a cold, wet cloth.</li> <li>■ Next time you bake, grease the baking tin/dish and sprinkle it with breadcrumbs.</li> </ul>
Sparks are generated between the tin and the wire rack.	<ul style="list-style-type: none"> <li>■ Check that the tin is clean on the outside.</li> <li>■ Change the position of the tin in the cooking compartment.</li> <li>■ Continue baking without the microwave and increase the baking time.</li> </ul>

## 23.6 Roasting and grilling

The temperature and roasting time depend on the consistency and amount of food being cooked. This is why temperature ranges are given in the tables. Begin with the lower temperature and, if necessary, use a higher setting the next time.

### Tips for roasting and braising

Use these tips for good results when roasting and braising.

Issue	Tip
Lean meat should not dry out.	<ul style="list-style-type: none"> <li>■ Coat lean meat with fat or oil as required or cover it with strips of bacon.</li> </ul>

## Combining the grill and microwave

### ATTENTION!

Acidic food may damage the grid

- ▶ Do not place acidic food, such as fruit or food with an acidic marinade directly on the pan support.

### Information for those allergic to nickel

In rare cases, small amounts of nickel may pass into the food.

### Note:













Cooking tips

- Use heat-resistant, microwave-safe cookware.
- Metal baking tins are not suitable for baking with microwaves.
- Place hot glass ovenware on a dry tea towel after cooking. The glass may crack if placed on a wet or cold surface.

Issue	Tip
You want to prepare joints with the rind on.	<ul style="list-style-type: none"> <li>■ Score the rind in a crosswise pattern.</li> <li>■ Roast the joint with the rind facing down first.</li> </ul>
Keep the cooking compartment as clean as possible.	<ul style="list-style-type: none"> <li>■ Cook the food in a covered roasting dish at a higher temperature.</li> </ul>
You want the meat (e.g. roast beef) to remain hot and succulent.	<ul style="list-style-type: none"> <li>■ When the roast is ready, switch off the oven and leave the meat to rest for 10 minutes in the cooking compartment with the door closed. This helps distribute the meat juices more evenly. The resting time is not included in the specified cooking time.</li> <li>■ After preparing it, wrap the food in aluminium foil.</li> </ul>
The recommended settings do not contain information for the weight of the joint.	<ul style="list-style-type: none"> <li>■ For small roasts, select a higher temperature and a shorter cooking time.</li> <li>■ For larger roasts, select a lower temperature and a longer cooking time.</li> </ul>
Determine when the roast is ready.	<ul style="list-style-type: none"> <li>■ Use a meat thermometer to measure the temperature.</li> <li>■ Spoon test: Press down on the roast with the spoon. If the roast feels firm, it is ready. If the spoon can be pressed in, the roast needs to be cooked for a little longer.</li> </ul>

- The temperature and baking time depend on the consistency and amount of the mixture. This is why temperature ranges are given in the tables. Begin with the lowest temperature and, if necessary, use a higher setting the next time.
- The times given apply to food placed in a cold cooking compartment.
- When preparing meat, cover the bottom of the cookware with water. Add slightly more liquid for pot roasts. Turn pieces of meat halfway through the cooking time. When the roast is ready, turn off the oven and allow it to rest for an additional 10 minutes. This allows for better distribution of the meat juices.
- Always grill food with the oven door open. Do not preheat.

- As far as possible, use pieces of food that are of equal thickness. Steaks should be at least 2 to 3 cm thick. This allows them to brown evenly and remain succulent and juicy. Only add salt to steaks once they have been grilled.
- Use grill tongs to turn the grilled items. If you pierce the meat with a fork, the juices will run out and it will become dry.
- Dark meat, e.g. beef, browns more quickly than lighter-coloured meat such as veal or pork. When grilling light-coloured meat or fish, these often only brown slightly on the surface, although they are cooked and juicy on the inside.
- The grill element switches off and on again automatically. This is normal. The grill setting determines how frequently this occurs.
- Use cookware with a lid for braising fish. Add two to three tablespoons of liquid and a little lemon juice or vinegar into the cookware.
- Pre-toast the slices of toast for toast with toppings.

Food	Weight	Cookware	Position	Microwave output setting	Type of heating	Temperature/grill setting	Duration
Pot-roasted beef	Approx. 1000 g	Covered cookware	0	180 W		160 – 170 °C	80 – 90 mins
Sirloin, medium rare <sup>1</sup>	Approx. 1000 g	Uncovered cookware	0	180 W		180 – 200 °C	30 – 40 mins
Pork without rind, e.g. neck	Approx. 750 g	Uncovered cookware	0	360 W		170 – 180 °C	35 – 45 mins
Boned pork with rind, e.g. shoulder <sup>2, 3</sup>	Approx. 1000 g	Uncovered cookware	0	180 W		170 – 180 °C	80 – 90 mins
Pork loin	Approx. 500 – 600 g	Uncovered cookware	0	180 W		180 – 190 °C	35 – 40 mins
Meatloaf	Approx. 750 g	Uncovered cookware	0	360 W		200 – 210 °C	30 – 35 mins
Chicken, whole <sup>4, 3</sup>	Approx. 1000 – 1200 g	Covered cookware	0	360 W		230 – 250 °C	30 – 40 mins
Chicken pieces, e.g. chicken quarters <sup>5, 3</sup>	Approx. 800 g	Uncovered cookware	0	360 W		230 – 250 °C	20 – 30 mins
Duck <sup>3</sup>	Approx. 1500 – 1700 g	Covered cookware	0	180 W		220 – 240 °C	70 – 80 mins
Duck breast <sup>5, 3</sup>	Approx. 500 g	Uncovered cookware	0	180 W		3	15 – 20 mins
Duck breast, 2 pcs <sup>5, 3</sup>	Approx. 250 – 300 g each	Uncovered cookware	0	180 W		3	15 – 20 mins
Goose breast, goose legs <sup>3</sup>	Approx. 700 – 900 g	Deep cookware without a lid	0	180 W		2	30 – 40 mins
Fish, with topping, not frozen	Approx. 500 g	Uncovered cookware	0	600 W		3	10 – 15 mins

<sup>1</sup> Turn the dish halfway through the cooking time.

<sup>2</sup> Score the rind.

<sup>3</sup> Do not turn the food.

<sup>4</sup> Place with the breast side up.

<sup>5</sup> Place with the skin side up.

Food	Weight	Cookware	Position	Type of heating	Grill setting	Duration
Steaks, 2 – 3 cm thick, 2 – 3 pcs	Approx. 200 g each	Wire rack + Glass pan	1+3		3	1st side: Approx. 10 – 15 mins 2nd side: Approx. 5 – 10 mins

<sup>1</sup> Grease the wire rack with oil beforehand.

Food	Weight	Cookware	Position	Type of heating	Grill setting	Duration
Neck steaks, 2 – 3 cm thick, 2 – 3 pcs	Approx. 120 g each	Wire rack + Glass pan	1+3	~~~~~	2	1st side: Approx. 15 – 20 mins 2nd side: Approx. 10 – 15 mins
Grilling sausages, 4 – 6 pcs	Approx. 150 g each	Wire rack + Glass pan	1+3	~~~~~	3	1st side: Approx. 10 – 15 mins 2nd side: Approx. 5 – 10 mins
Fish steak, 2 – 3 pcs	Approx. 150 g each	Wire rack <sup>1</sup> + Glass pan	1+3	~~~~~	3	1st side: Approx. 10 – 12 mins 2nd side: Approx. 8 – 12 mins
Fish, whole, e.g. trout, 2 – 3 pcs	Approx. 300 g each	Wire rack <sup>1</sup> + Glass pan	1+3	~~~~~	2	1st side: Approx. 10 – 15 mins 2nd side: Approx. 10 – 15 mins
Bread for toasting, 12 slices		Wire rack	3	~~~~~	3	1st side: Approx. 3 – 5 mins 2nd side: Approx. 2 – 3 mins
Toast with topping, 2 – 4 slices, pre-toasted		Wire rack + Glass pan	1+3	~~~~~	3	8 – 10 mins

<sup>1</sup> Grease the wire rack with oil beforehand.

### Tips for next time you roast

If roasting is not successful the first time, you can find some tips here.

Issue	Tip
Your roast is too dark and the crackling is partly burnt.	<ul style="list-style-type: none"> <li>Select a lower temperature.</li> <li>Reduce the roasting time.</li> </ul>
Your roast is too dry.	<ul style="list-style-type: none"> <li>Select a lower temperature.</li> <li>Reduce the roasting time.</li> </ul>
The crackling on your roast is too thin.	<ul style="list-style-type: none"> <li>Increase the temperature.</li> <li>Or:</li> <li>Switch on the grill briefly at the end of the roasting time.</li> </ul>
Your roasting juices are burnt.	<ul style="list-style-type: none"> <li>Select a smaller item of cookware.</li> <li>When roasting, add more liquid.</li> </ul>

Issue	Tip
Your roasting juices are too clear and watery.	<ul style="list-style-type: none"> <li>Use a larger item of cookware so that more liquid evaporates.</li> <li>When roasting, add less liquid.</li> </ul>
The meat catches during braising.	<ul style="list-style-type: none"> <li>Check whether the roasting dish and lid fit together and close properly.</li> <li>Reduce the temperature.</li> <li>Add liquid when braising.</li> </ul>
Your roast is not well-done enough.	<ul style="list-style-type: none"> <li>Carve the meat into portions.</li> <li>Prepare the juices in the roasting dish.</li> <li>Place the sliced meat in the juices.</li> <li>Place the slices of meat in the microwave to finish cooking.</li> </ul>

## 23.7 Bakes and gratins

### Note:

#### Cooking tips

- Use heat-resistant, microwave-safe cookware.
- The times given apply to food placed in a cold cooking compartment.
- For bakes and potato gratins, use large, flat cookware. Food takes longer to cook in narrow, deep containers, and it browns more on top.

- Leave bakes and gratins to cook in the switched-off oven for a further 5 minutes.

Food	Weight	Cookware	Position	Microwave output setting	Type of heating	Temperature	Duration
Bake, sweet, e.g. quark bake with fruit	Ap-prox. 1.5 kg	Uncovered cookware	0	180 W		130 – 150 °C	25 – 35
Bake, savoury, made with cooked ingredients	Ap-prox. 1 kg	Uncovered cookware	0	600 W		160 – 190 °C	20 – 30
Bake, savoury, made from raw ingredients, e.g. potato gratin	Ap-prox. 1.1 kg	Uncovered cookware	0	600 W		170 – 180 °C	25 – 35

### 23.8 Frozen convenience products

Observe the recommended settings for cooking frozen convenience products.

**Note:**

Cooking tips

- Follow the manufacturer's instructions on the packaging.
- The times given apply to food placed in a cold cooking compartment.

Food	Cookware	Position	Type of heating	Temperature	Duration
Strudel with fruit filling	Glass tray	2		200 – 220 °C	40 – 50 mins <sup>1</sup>
Chips	Glass tray	2		210 – 230 °C	20 – 30 mins
Pizza	Wire rack	2		180 – 200 °C	10 – 20 mins
Pizza baguette	Wire rack	2		160 – 190 °C	15 – 20 mins
Croquettes	Glass tray	2		200 – 220 °C	20 – 30 mins
Rösti	Glass tray	2		200 – 220 °C	20 – 30 mins

<sup>1</sup> Preheat the appliance for 5 minutes.

### 23.9 Test dishes

These overviews have been produced for test institutes to facilitate appliance testing in accordance with EN 60350-1:2013 or IEC 60350-1:2011 and EN 60705:2012, IEC 60705:2010.

#### Defrosting with the microwave

Food	Microwave output setting	Duration	Information
Meat, 500 g	1. 180 W 2. 90 W	1. 7 mins 2. 8 – 12 mins	Place the 22 cm diameter Pyrex dish on the cooking compartment floor. Alternative: Defrost "Minced meat" automatic programme

#### Cooking with the microwave

Food	Microwave output setting	Duration	Information
Custard, 1000 g	1. 600 W 2. 180 W	1. 11 – 12 mins 2. 15 – 20 mins	Place the Pyrex dish on the cooking compartment floor.
Sponge, 475 g	600 W	8 – 10 mins	Place the 22 cm diameter Pyrex dish on the cooking compartment floor.
Meat loaf, 900 g	600 W	25 – 30 mins	Place the Pyrex dish on the cooking compartment floor.

## Cooking with the microwave and grill

Food	Microwave output setting/type of heating	Duration	Information
Potato gratin	360 W + grill setting 1	30 – 35 mins	Place the 22 cm diameter round Pyrex dish on the cooking compartment floor.
Cakes	180 W + ✦ 190 – 200 °C	20 – 25 mins	Place the 22 cm diameter round Pyrex dish on the wire rack at level 1.
Chicken	360 W + ✦ 240 °C	30 – 35 mins	Put the chicken breast-side down in deep ovenware without a lid and place on the cooking compartment floor. Turn halfway through the cooking time.

## Baking

The setting values apply to food that is placed into a cold cooking compartment.

Food	Cookware and notes	Position	Type of heating	Temperature	Duration
Shortbread	Glass tray	2	✦	160 – 170 °C	30 – 35 mins
Small cakes	Glass tray	2	✦	160 – 170 °C	25 – 30 mins <sup>1</sup>
Hot water sponge cake	Springform cake tin on the wire rack	1	✦	170 – 180 °C	45 – 50 mins
Yeast tray bakes	Glass tray	2	✦	160 – 180 °C	50 – 60 mins
Double-crust apple pie	Dark 22 cm diameter springform cake tin on the wire rack	2	✦	170 – 190 °C	80 – 100 mins

<sup>1</sup> Preheat the appliance for 5 minutes.

## Grilling

The setting values apply to food that is placed into a cold cooking compartment.

Food	Cookware	Position	Type of heating	Grill setting	Duration
Toasting bread	Wire rack	3	~~~~~	3	4 – 5 mins
Beef burgers, 12 pcs	Wire rack and glass tray	3+1	~~~~~	3	30 – 35 mins <sup>1</sup>

<sup>1</sup> Turn the dish halfway through the cooking time.

# 24 Installation instructions

Observe this information when installing the appliance.



## 24.1 Safe installation

Follow these safety instructions when installing the appliance.

- The appliance can only be used safely if it is correctly installed according to the safety instructions. The installer is responsible for ensuring that the appliance works perfectly at its installation location.
- Check the appliance for damage after unpacking it. Do not connect the appliance if it has been damaged in transit.
- Before starting up the appliance, remove any packaging material and adhesive film from the cooking compartment and the door.
- Proceed in accordance with the installation sheets for installing accessories.
- Fitted units must be temperature-resistant up to 90 °C, and adjacent unit fronts up to 65 °C.

- Do not install the appliance behind a decorative door or the door of a kitchen unit. There is a risk of overheating.
- Cut-out work on the units should be carried out before installing the appliance. Remove any shavings. Otherwise, the correct operation of electrical components may be adversely affected.
- Only a licensed professional may connect appliances without plugs. Damage caused by incorrect connection is not covered under the warranty.

**⚠ WARNING – Risk of injury!**

Parts that are accessible during installation may have sharp edges and may lead to cutting injuries.

- ▶ Wear protective gloves.

**⚠ WARNING – Risk of fire!**

It is dangerous to use an extended power cord and non-approved adapters.

- ▶ Do not use extension cables or multiple socket strips.

### 24.2 Scope of delivery

After unpacking all parts, check for any damage in transit and completeness of the delivery.

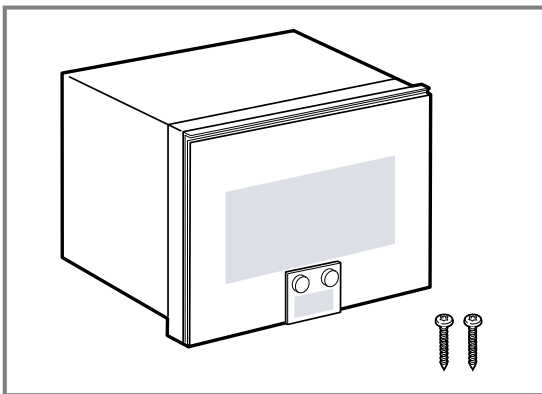

### 24.3 Appliance dimensions

You will find the dimensions of the appliance here

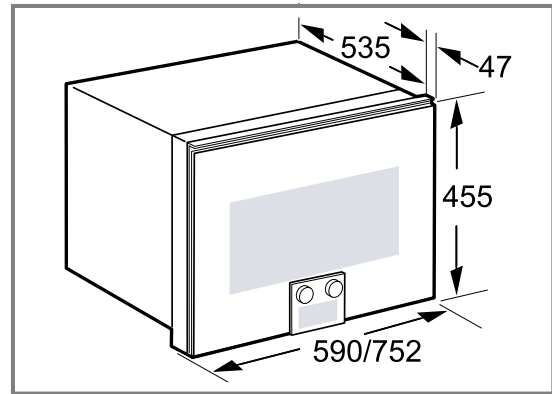

### 24.4 Fitted units

This appliance is only intended to be fully fitted in a kitchen. It is not intended to be used as a tabletop appliance or within a cupboard.

Ensure that the fitted cabinet behind the appliance does not have a back panel. Maintain a clearance of at least 45 mm between the wall and the cabinet base or the rear panel of the cabinet situated above.

Do not cover the ventilation slots and air intake openings.

Carry out all cut-out work on the kitchen unit and worktop before fitting the appliance.

Remove the shavings.

### 24.5 Electrical connection

In order to safely connect the appliance to the electrical system, follow these instructions.

- The appliance corresponds to protection class I and must only be operated with a protective earth connection.
- The fuse protection must correspond to the power rating specified on the appliance's rating plate and to the local regulations.
- The appliance must be disconnected from the power supply whenever installation work is being carried out.
- Contact protection must be guaranteed by the installation.
- If the plug is no longer accessible following installation, an all-pole isolating switch with a contact distance of at least 3 mm must be present.

#### Great Britain and Australia

Do not connect using a 13 A plug or protect with a 13 A fuse. The appliance must be protected using a 16 A fuse. The appliance must always be disconnected from the power supply when installation work is being carried out. Contact protection must be guaranteed by the installation.

#### Electrically connecting an appliance without a protective contact plug

**Note:** Only licensed specialists may connect the appliance. Damage caused by incorrect connection is not covered under the warranty.

An isolating switch must be integrated into the permanent electrical installation according to the installation regulations.

1. Identify the phase and neutral conductors in the socket.  
The appliance may be damaged if it is not connected correctly.
2. Connect the hob in accordance with the connection diagram.  
See the rating plate for the voltage.
3. Connect the wires of the mains power cable according to the colour coding:
  - Green/yellow = Protective conductor (⊕)
  - Blue = Neutral conductor
  - Brown = Phase (external conductor)

## 24.6 Appliance combinations

When combining with other appliances, note the following.

Only fit the appliance above a ventilated oven from the same manufacturer. If you want to install the appliance next to an oven, the handles of both appliances must be located in the centre. Installation above a refrigerator is possible.

## 24.7 Combination with a warming drawer

First fit the warming drawer. Follow the installation instructions for the warming drawer. Slide the appliance, on the warming drawer, into the fitted cabinet. When sliding in the appliance, do not damage the warming drawer's panel.

## 24.8 Installation in a tall unit

Observe the installation dimensions and the safety clearances in a tall unit.  
To ventilate the appliance, the intermediate floor must have a ventilation cut-out.

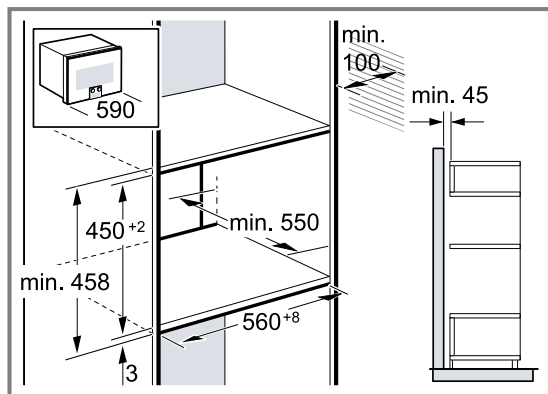

Dimensions for appliances with a width of 752 cm:

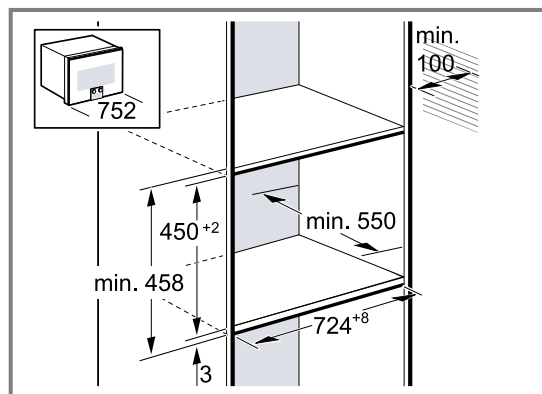

If the tall unit has another back panel in addition to the element back panels, this must be removed. Do not fit the appliance too high up; it must be possible for accessories to be removed easily.

## 24.9 Corner installation

Observe the installation dimensions and the safety clearances when installing in a corner.

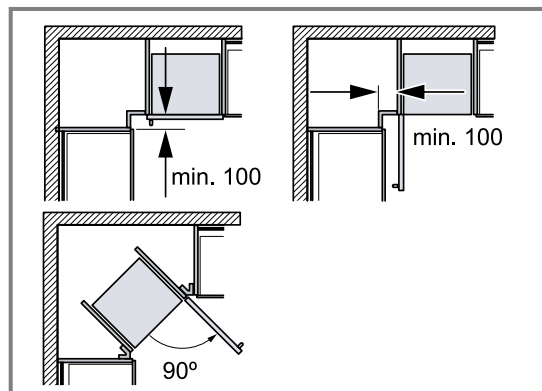

To ensure that the appliance door can be opened, you must take the minimum dimensions into consideration when installing in a corner.

## 24.10 Installing the appliance

### ATTENTION!

Carrying the appliance by the door handle could break it. The door handle cannot support the weight of the appliance.

- ▶ Do not carry or hold the appliance by the door handle.

The control panel may be damaged by setting it down on the floor.

- ▶ Never place appliances on the floor with the control panel at the bottom. Underlay with wooden strips.
- ▶ Never raise appliances sloping from the rear with the control panel at the bottom.

1. Push the appliance in fully.  
Do not kink or trap the connection cable, or route it over sharp edges.
2. Align the appliance horizontally and centrally.
3. Use a spirit level to adjust the appliance so that it is perfectly level.

4. Pre-drill the hole on the hinge side.

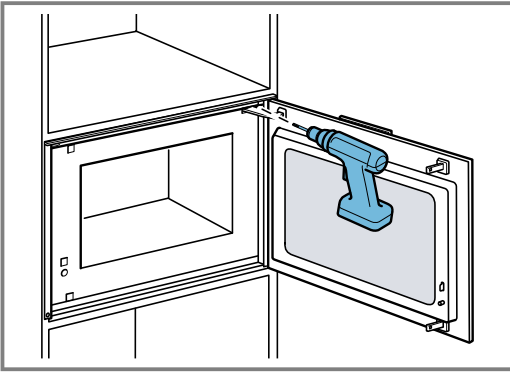

5. Screw the appliance tightly onto the unit.

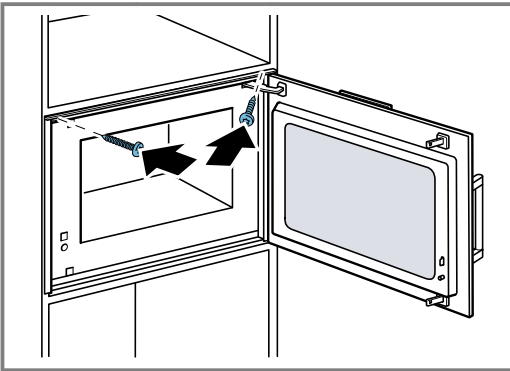

6. Remove any packaging material and adhesive film from the cooking compartment and the door.

### 24.11 Removing the appliance

1. Disconnect the appliance from the power supply.
2. Undo the fastening screws.
3. Lift the appliance slightly and pull it out completely.









**BSH Hausgeräte GmbH**  
Carl-Wery-Straße 34  
81739 München, GERMANY  
[www.gaggenau.com](http://www.gaggenau.com)

**GAGGENAU**



9001804507 en (030302)